

Education on Vehicle Electrification: Battery Systems, Fuel Cells, and Hydrogen

(Special Session: New Vehicle Education Programs)

Scott J. Moura, Jason B. Siegel, Donald J. Siegel, Hosam K. Fathy, Anna G. Stefanopoulou

Department of Mechanical Engineering

University of Michigan, Ann Arbor

Ann Arbor, Michigan USA 48109-2125

Email: {sjmoura,siegeljb,djsiege,hfathy,annastef}@umich.edu

Abstract—A new education program is under development at the University of Michigan to educate engineers in the fundamentals of electrochemical propulsion systems for vehicle electrification. This paper describes two courses that are part of this larger program: “Battery Systems & Control” and “Fuel Cell Vehicles & Hydrogen Infrastructure.” These courses seek to educate undergraduate, graduate, and professional (i.e. distance learning) students in the fundamentals of modeling, control, and design of batteries, fuel cells, and hydrogen storage systems. These courses apply a systems-level approach to electrochemical propulsion systems with particular emphasis placed on modeling, design, and control issues encountered in practice. In the battery course students are introduced to electrochemical-based models, model reduction techniques, simulation procedures, and real-life control problems such as state-of-charge estimation. Topics covered in the fuel cell course include: PEM fuel cell operating fundamentals, hydrogen production pathways, hydrogen storage, and well-to-wheels CO₂ and efficiency analyses. This paper broadly outlines the curriculum for both courses using specific assignments as illustrative examples of the program’s content. Together these two courses provide fundamental skills directed at developing engineering leadership and knowledge in sustainable transportation systems.

I. INTRODUCTION

This paper describes two courses under development at the University of Michigan, Ann Arbor, focusing on battery systems and fuel cells-hydrogen storage for automotive applications. The objective is to provide to undergraduate, graduate, and professional students the technical skills necessary for developing a new generation of green vehicle technology. Emphasis is placed upon systems-level modeling, design, and control, oriented towards solving issues relevant for new vehicle development. The battery course specifically focuses on system-level modeling, model order reduction from electrochemical models to surrogate models for load control, estimation, on-board identification and diagnostics for lithium-ion batteries. The hydrogen and fuel cell course focuses on system-level modeling and control issues of polymer electrolyte membrane (PEM) fuel cells, materials and systems for on-board hydrogen storage, hydrogen production, and well-to-wheels (WTW) analyses of CO₂ emissions and efficiency. Together these courses constitute a comprehensive curriculum on vehicle electrification systems aimed toward invigorating and transforming the automotive industry’s workforce.

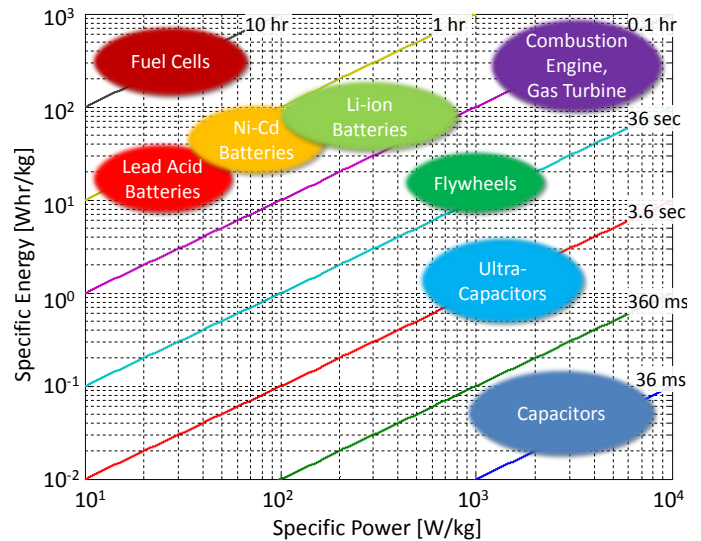

Fig. 1: Ragone plot of various energy storage/propulsion devices and their “charge” times. Adapted from US Defense Logistics Agency Report [1].

The performance characteristics of batteries and fuel cells can be placed in context with those of other energy storage & conversion devices by their specific power and energy density, as demonstrated by the Ragone plot in Fig. 1. The sloped lines indicate the relative time required to extract and/or store energy from the device. This figure demonstrates that both batteries and fuel cells have high theoretical specific energy, but lower power density when compared to conventional internal combustion (IC) engines. For this reason, batteries and fuel cells are sometimes combined with high specific power devices to form “hybrid” vehicle propulsion systems that achieve the desirable power characteristics. Whether used in solitary or hybrid applications, there exists a plethora of systems-level integration issues for both battery and fuel cell systems, upon which modeling, design, and control play key roles. Given their novelty and potential for reducing the carbon intensity of the transportation sector [2], there is a great need for courses that introduce the fundamental features of these systems as well as strategies for their integration.

TABLE I: Outline of Course Topics & Winter 2010 Enrollment

Battery Systems & Control
Winter 2010 Enrollment: 59 (including 5 distance learning students)
<ul style="list-style-type: none"> • Overview of chemistries, technologies, and challenges • Equivalent circuit and electrochemical models • Model reduction techniques and applications • SOC estimation & HEV power management • Battery health degradation modeling and control • Battery pack management systems • Projects on topics not covered in class
Fuel Cell Vehicles & Hydrogen Infrastructure
Winter 2010 Enrollment: 47 (including 4 distance learning students)
<ul style="list-style-type: none"> • Fuel cell vehicle and hydrogen state of art and challenges • PEM fuel cell modeling • The air, thermal, and water management problems • Hydrogen production technologies • Hydrogen distribution infrastructure • Hydrogen storage: materials and systems • Life-cycle and Wheel-to-Wells Analysis

An outline of topics for both courses is provided in Table I, along with student enrollment numbers for the first offering in the Winter 2010 term. The pedagogical approach in both courses is to (1) examine high-level technical challenges and applications, (2) focus in on fundamental tools and theory necessary to solve specific problems, and (3) allow students to exercise these tools on practical issues through application driven homework assignments and projects.

The outline of this paper is as follows: In Section II we discuss the methodology behind a systems-level modeling approach. Specifically, this section discusses the construction of first-principle models, model reduction, and finally simulation tools and techniques. In Section III we introduce estimation and control problems relevant for vehicular applications. Examples discussed from the battery course include state-of-charge estimation and charge balancing control. Finally Section IV summarizes the course objectives and planned improvements.

II. SYSTEM-LEVEL MODELING, REDUCTION, AND SIMULATION

Mathematical models of electrochemical propulsion devices span a spectrum - from high-fidelity physics-based models to simplified phenomenological models. The appropriate balance between model accuracy and simplicity depends on the specific modeling objective. For example, if one desires to design improved material structural properties for a battery or fuel cell electrode, it may be important to account for particle-level mechanical stresses and electrochemical kinetics. However, if the aim is to analyze life cycle carbon footprints, then a relatively simple phenomenological model may suffice. The main focus of these courses falls near the middle of the spectrum - a systems-level model appropriate for powertrain integration, design, and control. As such, both courses apply the following pedagogical modeling approach: First, construct

a high fidelity physics-based model suitable for validation or high accuracy simulation purposes. Then, depending on the modeling objective, utilize model reduction and simulation techniques to achieve the desired tradeoff between model accuracy and computational complexity. The subsequent three subsections describe how this process is applied within the context of both propulsion systems, utilizing specific examples from the courses.

A. Model Development

1) *Electrochemical-based Lithium-ion Battery Models*: The battery systems and control course presents students with physical models of lithium-ion batteries based on electrochemistry principles [3]. These models are useful for vehicular applications because they explicitly predict critical system states (e.g. cell state-of-charge) and physical operating constraints (e.g. charge/discharge limits). These characteristics are important when considering the highly transient loading conditions typically experienced in automotive applications. In particular, the students are introduced to the electrochemical model of lithium-ion cells originally developed by Doyle, Fuller, and Newman [4], [5]. Due to the importance of battery lifetime, we also review degradation mechanisms. Throughout this discussion we emphasize fundamental principles, since the students generally do not have extensive background in electrochemistry or materials science.

The model by Doyle, Fuller, and Newman, described schematically in Fig. 2, captures the spatiotemporal evolution of phenomena such as diffusion dynamics, reaction kinetics, and electric potential. The model is divided into three sections: anode, separator, and cathode. Each electrode contains an electrolyte solution, represented by the x-axis in Fig. 2. The anode also contains a solid material (typically carbon, graphite, or coke). The cathode material structure varies across manufacturers but the most common chemistries include cobalt-oxide (LiCoO_2), manganese (LiMn_2O_4), polymer (Co/Mn), and iron-phosphate (LiFePO_4). The solid materials in each electrode are modeled by porous spherical particles which lithium-ions can penetrate during the charge and discharge processes.

2) *Polymer Electrolyte Membrane Fuel Cells (PEMFCs) and Hydrogen Storage*: During operation of PEM fuel cells, hydrogen supplied to the anode channels diffuses through the Gas Diffusion Layer (GDL) to the catalyst layer (CL), where it disassociates into protons and electrons. The protons are transported through the membrane to the cathode side, while the electrons travel back through the carbon structure of the GDL and through an external circuit, providing useful work. The protons crossing the membrane combine with oxygen and electrons to form heat and liquid water. The liquid water, produced in the cathode catalyst layer, must be effectively removed or else it can cover the catalyst sites preventing the reaction. On the other hand, over drying of the membrane is undesirable as it increases protonic resistance which yields lower cell efficiency. Consequently, the water management issue is a critical problem discussed in the course.

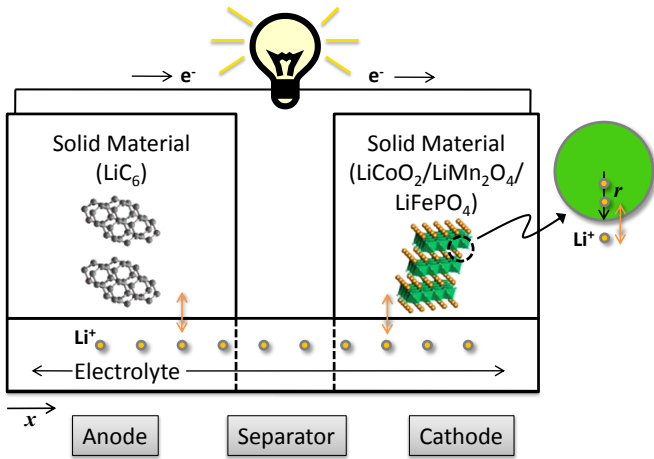

Fig. 2: Structure of electrochemical Li-ion battery cell model.

The PDE modeling framework, and the equations which describe the operation of a PEM fuel cell are very similar to the battery system. The system performance is limited by reactant (gas) transport, specifically the diffusion of oxygen from the channel through the GDL to the catalyst sites. The terminal voltage is calculated from the theoretical open circuit voltage minus the anode and cathode over-potentials, which are also calculated using a Butler-Volmer equation, and ohmic losses. However, unlike the battery system where all of the reactants are contained within the device, the problem of reactant delivery and the removal of product water (a two-phase system with both liquid and vapor) compound the difficulty of controlling these devices. Specific examples from research on “control of fuel cell breathing” for cathode air flow are used to elucidate the challenges of supplying reactants during step changes of load current in power-autonomous fuel cells when the air compressor is driven directly by the fuel cell [6].

Widespread adoption of hydrogen as a vehicular fuel depends critically upon the ability to store hydrogen on-board at high volumetric and gravimetric densities, as well as on the ability to extract it/refuel at sufficiently rapid rates [7]. As current storage methods based on physical means - high-pressure gas or (cryogenic) liquefaction - are unlikely to satisfy targets for performance and cost, in this course we describe the potential for using chemical means to store hydrogen in condensed phases. At present, no known material exhibits a combination of properties that would enable high-volume automotive applications. Thus new materials with improved performance, or new approaches to the synthesis and/or processing of existing materials, are highly desirable [8]–[10]. Starting from the general requirements of a fuel cell vehicle, the course illustrates how these requirements translate into desired characteristics for the hydrogen storage material. Key amongst these are: (a) high gravimetric and volumetric hydrogen density, (b) thermodynamics that allow for reversible hydrogen uptake/release under near-ambient conditions, and

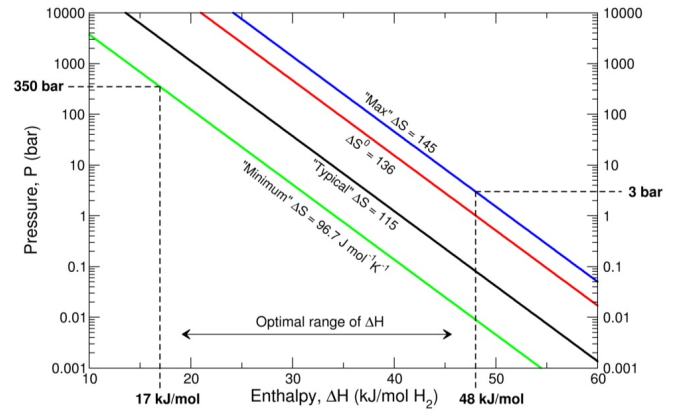

Fig. 3: Equilibrium H_2 desorption pressure (P) for a generic hydrogen storage material as a function of desorption enthalpy (ΔH) for various choices of desorption entropy (ΔS) at $T = 80^\circ C$. Adapted from Ref. [7]. The minimum pressure for the fuel cell inlet is taken to be 3 bar; the refueling pressure is assumed to be 350 bar.

(c) fast reaction kinetics. Regarding thermodynamics, Fig. 3 illustrates how the operating conditions of a fuel cell (minimum 3 bar inlet H_2 pressure, 80 C waste heat) in conjunction with the properties of the forecourt (350 bar H_2 refueling pressure) determine an optimal range of desorption enthalpy (approximately 20-50 kJ/mol H_2) for a hypothetical hydrogen storage reaction.

To further illustrate desired attributes of the storage system, the four major classes of candidate storage materials - conventional metal hydrides, chemical hydrides, complex hydrides, and sorbent systems - are introduced and their respective performance and prospects for improvement in each of these areas is discussed. Finally, and although not specifically related to vehicle systems and controls, we discuss two additional areas of relevance to FC vehicles; (i) aspects of a possible hydrogen fuel infrastructure, including advantages and disadvantages associated with various approaches to hydrogen production and distribution [11], and (ii) well-to-wheels analyses of the CO_2 emissions, fossil fuel consumption, and energy efficiency of FC and other vehicle technologies [2]. An example of the course content focused on the latter topic is illustrated using a WTW study performed by Argonne National Laboratories, Fig. 4. This study [2] found that electric vehicles can lead to a reduction in emissions and petroleum use compared to conventional gasoline vehicles. However, the magnitude of that reduction depends sensitively upon the production pathway for electricity or hydrogen.

B. Model Reduction

The high-fidelity physical models of lithium-ion battery cells and PEM fuel cells discussed above are well-suited toward high accuracy simulation and validation. However, they generally are not implementable on a real-time on-board electronic control unit for automotive applications. As such, we

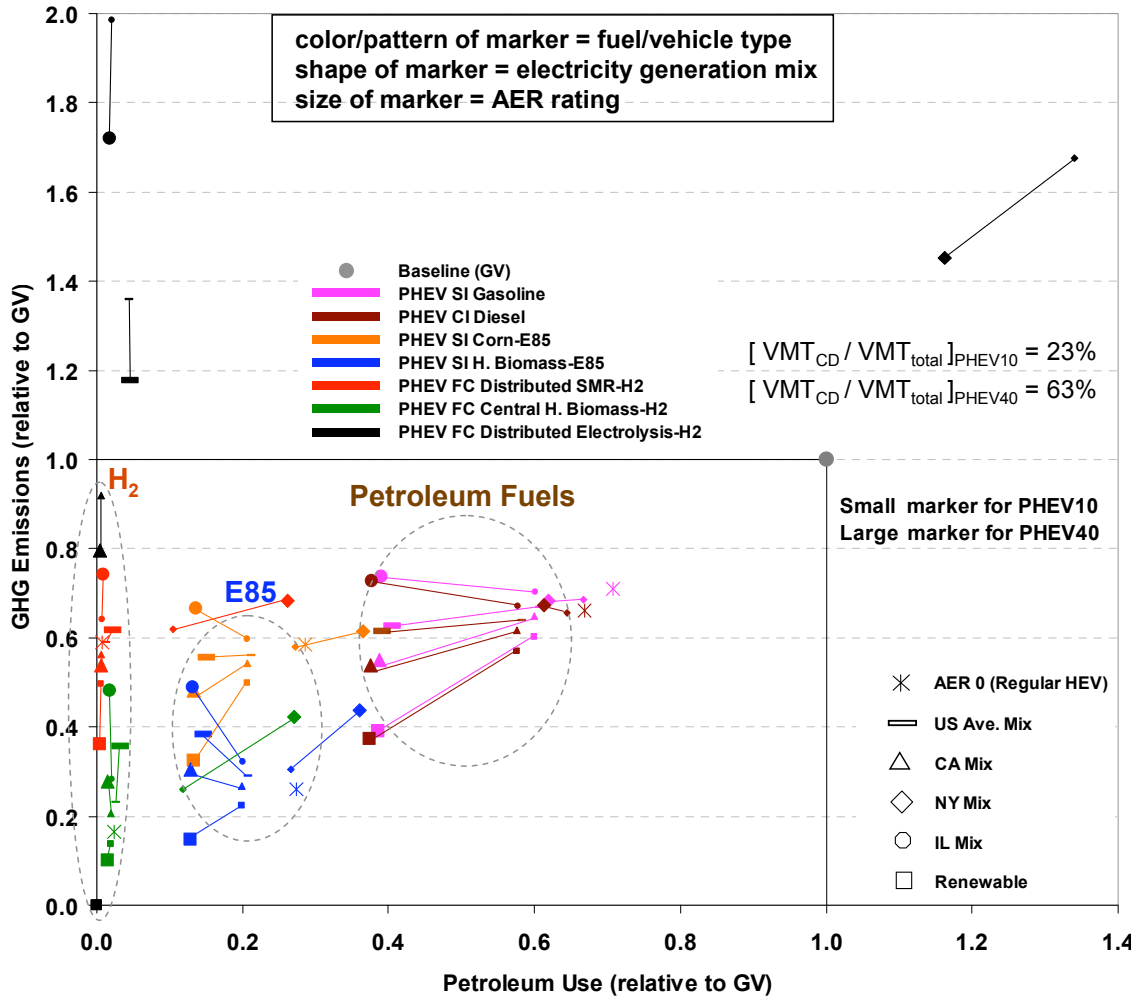

Fig. 4: Comparison of well-to-wheels petroleum energy use and greenhouse gas emissions for gasoline (GV), hybrid electric (HEV), and plug-in hybrid electric [PHEV, with all electric range (AER) of 10 or 40 mi] vehicles as a function of fuel type or electricity source. Data are normalized relative to the performance of a GV at coordinates (1.0, 1.0). Adapted from Ref. [2].

introduce the students to approximation methods that preserve important system dynamics while eliminating unnecessary complexity within the context of the control objective. This process, known as model reduction, is fundamental to almost all practical system-level modeling and control problems - particularly in automotive applications.

Several battery model reduction techniques are discussed in the class, including the electrode average model [12], Padé approximations, and constraint linearization [13]. For several assignments we consider the following example: Suppose our battery system does not experience extreme charge/discharge loads such that the concentration distributions along the length of the electrodes and separator remain fairly constant. In this case, it may be reasonable to approximate the spatial distributions by their average values. This produces the so-called electrode average model shown schematically in Fig. 5. The reduced model equations that result after applying this concept produce a state-space system with linear dynamics and

a nonlinear output equation. The linear dynamics correspond to spherical diffusion in the solid material of the electrodes. The output equation computes cell voltage, which is nonlinear due to the thermodynamic and kinetic properties of the battery. The structure of this reduced model is extremely appealing for control applications, rendering it amenable to a vast range of control and estimator design techniques. In Section III we describe how students utilize this model to design a Kalman filter for SOC estimation.

C. Simulation Tools & Techniques

Given the mathematical physics-based models for each system, the next step for students is to develop simulation techniques. Nonlinear partial differential-algebraic equation systems, which characterize both battery and fuel cells, are typically difficult to simulate numerically.

To give students some appreciation for these issues, we instruct them to simulate a simple linear diffusion PDE us-

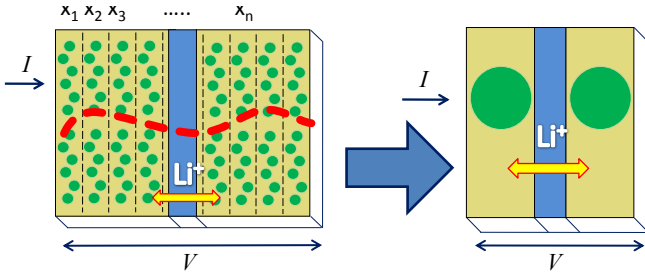

Fig. 5: Conceptual description of the electrode average model, which approximates each electrode as a single porous particle immersed in a zero-dimensional solution.

ing several finite differencing methods: forward-differences and Crank-Nicholson [14]. These two methods produce numerical simulations that are, respectively, conditionally-stable and unconditionally-stable. That is, the forward-differences method requires a condition on the discrete simulation time-step to be satisfied in order to obtain physically meaningful results. The students discover that for discretizations of the spatial dimension typical for battery or fuel cell models, the time step must be prohibitively small (on the order of $1\mu s$). This motivates the use of more elegant finite differencing methods, such as Crank-Nicholson, which are unconditionally stable. That is, they produce stable simulations for any given time step, although the simulations themselves are not necessarily accurate for large time steps.

Through this focused exercise, students learn about the techniques associated with simulating partial differential equation systems. Once mastering this basic skill, students have the foundational knowledge for simulating systems of PDE's representing more complex electrochemical devices.

III. ESTIMATION AND CONTROL PROBLEMS

Following the model development, reduction, and simulation of the battery and fuel cell system models, we turn the students' attention toward practical estimation and control problems. The scope of these problems involve systems-level integration issues often encountered in vehicle applications. Examples from the battery course include SOC estimation [12], HEV power management [15], charge balancing in battery packs [16], [17], and PHEV charging pattern optimization [18]. Examples from the fuel cell course include air flow [19] and water management [20], [21]. Due to space constraints we only discuss the battery SOC estimation and charge balancing problems in detail here.

A. The Battery SOC Estimation Problem

In the battery course the students are instructed to solve the most prominent battery estimation problem - SOC estimation. In many battery powered systems (e.g. laptops, electronic portable devices, and electric vehicles) one typically desires to know the battery SOC level, which represents the remaining available energy. Unfortunately, it is often impractical to implement sensors that directly measure the lithium-ion

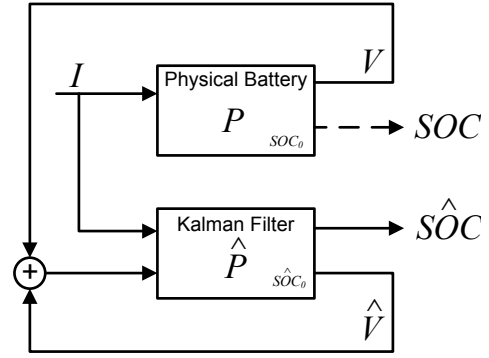

Fig. 6: Block diagram of SOC estimation scheme using the electrode average model and a Kalman filter.

concentration in the solid material of the electrodes. We do, however, typically have access to voltage and current measurements. These measurements in combination with a control-oriented battery cell model allow us to dynamically estimate SOC [12]. A block diagram of the estimation scheme is provided in Fig. 6.

In this assignment the students apply a linearized version of the electrode average model described in section II-B with a Kalman filter to estimate battery SOC. The students then learn how Kalman filters can be tuned to tradeoff sensor noise with modeling errors by injecting Gaussian noise into the measured signals and applying incorrect initial conditions to the estimator. Consequently, the students learn about Kalman filtering theory while simultaneously solving a very practical battery systems problem using physical models developed in class.

B. The Battery Charge Balancing Problem

A second battery systems and control problem relevant for vehicle applications is charge balancing. This problem is motivated by the fact that cells connected in series within battery packs may have unequal charge levels. This situation is problematic because individual cells can be inadvertently overcharged or over-discharged because the battery management system considers total battery pack voltage without knowledge of individual cell voltage. The end result is accelerated battery pack degradation and possibly catastrophic thermal runaway. This situation can be mitigated via a charge balancing scheme. A survey of such schemes can be found in [22].

In this assignment the students design and simulate a battery management system that utilizes shunt resistors to balance the voltage levels of two unbalanced cells connected in series. A schematic of the balancing scheme is shown in Fig. 7. The students are instructed to use their creativity to design logic that compares the individual voltage levels to actuate the switches in a manner that equalizes cell voltage. Moreover, they are free to design the resistance value of the shunt resistors. They use simulation results and mathematical arguments to analyze how the shunt resistor method suffers from an inherent tradeoff between equalization time and power

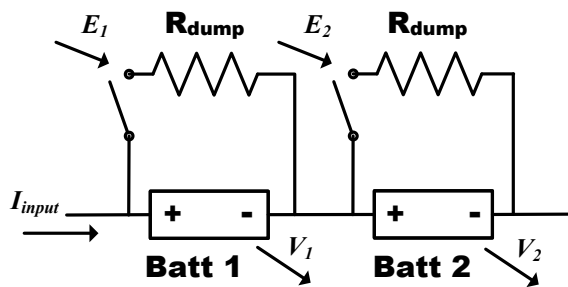

Fig. 7: Circuit diagram of shunt resistor equalization circuit.

efficiency. Finally, they discover how voltage balancing does not necessarily balance SOC, motivating the application of SOC balancing schemes [16].

IV. CONCLUSION

This paper describes newly developed courses in electrochemical vehicle propulsion systems at the University of Michigan, Ann Arbor, focused on system-level modeling, design, and control. The objective of these courses is to educate a new generation of engineers capable of developing advanced sustainable transportation systems. Specifically, the courses focus on system-level modeling, simulation, estimation, and control issues in battery and hydrogen fuel cell powered vehicles.

For the first offering of each course, topics were covered in a conceptual manner. However, we recognize that student engagement thrives on application case studies and hardware experiments. In future terms we will add laboratory components to each course. This equipment will be shared for instruction across multiple courses and research across multiple teams/departments, thus financially benefiting from high-throughput. For education in the battery systems and control course, the students will solve homework problems via analysis and simulation first, then apply their designs to a laboratory battery test system. We also plan to expand the topics to include thermal modeling and control, capacity fade management, and vehicle/infrastructure integration issues. For the Hydrogen and Fuel Cells course, we envision including a laboratory demonstration of hydrogen storage in solid state materials and examples of prototype storage systems. Pedagogically, these enhancements will marry conceptual analysis with hardware implementation - effectively increasing the impact and accessibility of each course. Through these efforts we anticipate a profound impact on job creation in sustainable transportation systems through education.

ACKNOWLEDGMENT

This material is based upon work supported by the Department of Energy National Energy Technology Laboratory under Award Number DE-EE0002119. The project is a joint collaboration between the University of Michigan-Ann Arbor, the University of Michigan-Dearborn, and Kettering University.

REFERENCES

- [1] P. Flynn and et al., *Meeting the Energy Needs of Future Warriors*, Committee on Soldier Power/Energy Systems, Board on Army Science and Technology, National Research Council of the Nation Academies, Ed. The National Academies Press, 2004.
- [2] A. Elgowainy, A. Burnham, M. Wang, J. Molburg, and A. Rousseau, "Well-to-Wheels Energy Use and Greenhouse Gas Emissions Analysis of Plug-in Hybrid Electric Vehicles," Argonne National Laboratory, Tech. Rep. ANL/ESD/09-2, 2009.
- [3] J. Newman and K. Thomas-Alyea, *Electrochemical Systems*. John Wiley & Sons, Inc., 2004.
- [4] M. Doyle, T. F. Fuller, and J. Newman, "Modeling of galvanostatic charge and discharge of the lithium/polymer/insertion cell," *Journal of the Electrochemical Society*, vol. 140, no. 6, pp. 1526–33, 06 1993.
- [5] T. F. Fuller, M. Doyle, and J. Newman, "Simulation and optimization of the dual lithium ion insertion cell," *Journal of the Electrochemical Society*, vol. 141, no. 1, pp. 1–10, 01 1994.
- [6] K.-W. Suh and A. G. Stefanopoulou, "Performance Limitations of Air Flow Control in Power-Autonomous Fuel Cell Systems," *IEEE Transactions on Control Systems Technology*, vol. 15, no. 3, pp. 465–473, May 2007.
- [7] J. Yang *et al.*, "High capacity hydrogen storage materials: attributes for automotive applications and techniques for materials discovery," *Chemical Society Reviews*, vol. 39, no. 2, pp. 656–675, 2010.
- [8] G. Lewis *et al.*, "High throughput screening of the ternary LiNH₂-MgH₂-LiBH₄ phase diagram," *Journal of Alloys and Compounds*, vol. 446, pp. 355–359, 2007.
- [9] D. Siegel, C. Wolverton, and V. Ozolins, "Thermodynamic guidelines for the prediction of hydrogen storage reactions and their application to destabilized hydride mixtures," *Physical Review B*, vol. 76, no. 13, 2007.
- [10] J. Yang *et al.*, "A self-catalyzing hydrogen-storage material," *Angewandte Chemie-International Edition*, vol. 47, no. 5, pp. 882–887, 2008.
- [11] D. A. J. Rand and R. M. Dell, *Hydrogen Energy: Challenges and Prospects*. Cambridge, England: Royal Society of Chemistry Publishing, 2008.
- [12] D. Domenico, A. Stefanopoulou, and G. Di Fiengo, "PSM: Lithium-Ion Battery State of Charge (SOC) and Critical Surface Charge (CSC) Estimation using an Electrochemical Model-driven Extended Kalman Filter," *submitted to a special issue of ASME Journal of Dynamic Systems, Measurements and Control*, 2009.
- [13] J. Forman, S. Bashash, H. Fathy, and J. Stein, "Reduction of an Electrochemistry-based Li-ion Battery Health Degradation Model via Constraint Linearization and Padé Approximation," *In preparation for submission to Journal of the Electrochemical Society*.
- [14] R. L. Burden and D. Faires, *Numerical Analysis, Ed. 7*. Brooks/Cole.
- [15] S. J. Moura, H. K. Fathy, D. S. Callaway, and J. L. Stein, "A Stochastic Optimal Control Approach for Power Management in Plug-in Hybrid Electric Vehicles," *accepted to IEEE Transactions on Control Systems Technology*, 2010.
- [16] C. Speltino, D. Di Domenico, G. Fiengo, and A. G. Stefanopoulou, "Cell Equalization In Battery Stacks Through State Of Charge Estimation Polling," in *Proceedings of the 2010 American Control Conference*, 2010.
- [17] S. J. Moura, J. C. Forman, S. Bashash, J. L. Stein, and H. K. Fathy, "Optimal Control of Film Growth in Lithium-Ion Battery Packs via Relay Switches," *submitted to IEEE Transactions on Industrial Electronics*, 2009.
- [18] S. Bashash, S. J. Moura, and H. K. Fathy, "Plug-in Hybrid Electric Vehicles Charge Pattern Optimization for Energy Cost and Battery Health," *submitted to Journal of Power Sources*, 2010.
- [19] J. T. Pukrushpan, A. G. Stefanopoulou, and H. Peng, *Control Of Fuel Cell Power Systems*. Springer, 2004.
- [20] D. A. McKay, J. B. Siegel, W. Ott, and A. G. Stefanopoulou, "Parameterization and prediction of temporal fuel cell voltage behavior during flooding and drying conditions," *Journal of Power Sources*, vol. 178, no. 1, pp. 207–222, Mar. 2008.
- [21] W. Schmittinger and A. Vahidi, "A review of the main parameters influencing performance and durability of PEM fuel cells," *Journal of Power Sources*, vol. 180, pp. 1–14, 2008.
- [22] A. Baughman and M. Ferdowsi, "Battery charge equalization-state of the art and future trends," *SAE Transactions: Electronic and electrical systems, Paper No. 2005-01-3474*, 2005.