

## Special Paper

# Oxidant Enhancement in Martian Dust Devils and Storms: Implications for Life and Habitability

SUSHIL K. ATREYA,<sup>1</sup> AH-SAN WONG,<sup>1</sup> NILTON O. RENNO,<sup>1</sup> WILLIAM M. FARRELL,<sup>2</sup>  
GREGORY T. DELORY,<sup>3</sup> DAVIS D. SENTMAN,<sup>4</sup> STEVEN A. CUMMER,<sup>5</sup>  
JOHN R. MARSHALL,<sup>6</sup> SCOT C.R. RAFKIN,<sup>7</sup> and DAVID C. CATLING<sup>8,9</sup>

### ABSTRACT

We investigate a new mechanism for producing oxidants, especially hydrogen peroxide ( $H_2O_2$ ), on Mars. Large-scale electrostatic fields generated by charged sand and dust in the martian dust devils and storms, as well as during normal saltation, can induce chemical changes near and above the surface of Mars. The most dramatic effect is found in the production of  $H_2O_2$  whose atmospheric abundance in the “vapor” phase can exceed 200 times that produced by photochemistry alone. With large electric fields,  $H_2O_2$  abundance gets large enough for condensation to occur, followed by precipitation out of the atmosphere. Large quantities of  $H_2O_2$  would then be adsorbed into the regolith, either as solid  $H_2O_2$  “dust” or as re-evaporated vapor if the solid does not survive as it diffuses from its production region close to the surface. We suggest that this  $H_2O_2$ , or another superoxide processed from it in the surface, may be responsible for scavenging organic material from Mars. The presence of  $H_2O_2$  in the surface could also accelerate the loss of methane from the atmosphere, thus requiring a larger source for maintaining a steady-state abundance of methane on Mars. The surface oxidants, together with storm electric fields and the harmful ultraviolet radiation that readily passes through the thin martian atmosphere, are likely to render the surface of Mars inhospitable to life as we know it. **Key Words:** Mars—Oxidants—Hydrogen peroxide—Triboelectricity—Electrostatic fields—Dust devils—Dust storms—Saltation—Organics—Methane—Habitability—Life. *Astrobiology* 6, 439–450.

---

<sup>1</sup>Department of Atmospheric, Oceanic, and Space Sciences, University of Michigan, Ann Arbor, Michigan.

<sup>2</sup>Laboratory for Extraterrestrial Physics, NASA Goddard Space Flight Center, Greenbelt, Maryland.

<sup>3</sup>Space Sciences Laboratory, University of California, Berkeley, California.

<sup>4</sup>Geophysical Institute, University of Alaska, Fairbanks, Alaska.

<sup>5</sup>Department of Electrical and Computer Engineering, Duke University, Durham, North Carolina.

<sup>6</sup>SETI Institute, Mountain View, California.

<sup>7</sup>Southwest Research Institute, Boulder, Colorado.

<sup>8</sup>Department of Atmospheric Sciences/Astrobiology Program, University of Washington, Seattle, Washington.

<sup>9</sup>Department of Earth Sciences, University of Bristol, Bristol, United Kingdom.

## INTRODUCTION

EVER SINCE THE VIKING Gas Chromatograph Mass Spectrometer found no trace of organics on Mars nearly 3 decades ago, controversy about the presence of life on the planet now or in the past has been escalating. The recent mineralogical measurements made by the Mars Exploration Rover Opportunity indicate that liquid water was present at Meridiani Planum in the past (Squyres *et al.*, 2004). The Mars Odyssey neutron detector experiment provides evidence of water ice in the first meter of the martian regolith, spread non-uniformly over the planet (Feldman *et al.*, 2002). The Mars Express Planetary Fourier Spectrometer has detected trace quantities of methane in the martian atmosphere (Formisano *et al.*, 2004), and the same has been found by two ground-based telescopes (Krasnopolsky *et al.*, 2004; Mumma *et al.*, 2004). The above findings provide tantalizing clues to the possibility of extant or extinct life on Mars. On the other hand, chemolithotrophic microbial colonies are but one of several possibilities for the source of methane (or other more complex organic molecules, if detected), and the process of serpentinization at low temperatures (40–90°C), involving the hydration of ultramafic silicates, could be just as effective (Atreya and Wong, 2004; Atreya *et al.*, 2004, 2006; Formisano *et al.*, 2004; Atreya, 2005). An understanding of potential sinks of methane and other organics is important for constraining the source scenarios.

Irrespective of the source, the absence of organics at the surface, including any methane that diffuses into the regolith, is puzzling. Although some doubts were raised about the ability of the Viking Gas Chromatograph Mass Spectrometer to detect organics in the martian surface, no convincing evidence of organics has been found to date in remote observations either. Even if there were no organics indigenous to Mars, vast quantities of organic material must have been delivered by meteorites, comets, and interplanetary dust particles over the past 4.5 billion years. Meteorites alone deliver approximately 300 g/s or ~9,000 tons/year of micrometeoritic dust to Mars (Flynn, 1996), some fraction of it in the form of organic material. Although much of the dust would be oxidized in the atmosphere, nearly a quarter (~2,300 tons/year) is expected to reach the surface. Assuming a constant rate of influx over the geologic time, this would amount to ap-

proximately 300 kg/m<sup>2</sup> of micrometeoritic dust that would reach the surface of Mars intact. Organic material makes up a small fraction of this dust, with ~3% by weight in the case of carbonaceous chondrites such as Orgueil or Murchison meteorites (Cronin *et al.*, 1988). This organic material would accumulate on the surface, along with the organic material from the other above-mentioned extraplanetary sources. Why has it not been detected then?

It has been suggested that the organics could have been destroyed by an oxidizer, such as hydrogen peroxide (H<sub>2</sub>O<sub>2</sub>) or another superoxide, present at the “surface” of Mars (Oyama *et al.*, 1977). Indeed, photochemical processes produce H<sub>2</sub>O<sub>2</sub> gas in the martian atmosphere (Krasnopolsky *et al.*, 1993; Atreya and Gu, 1994; Nair *et al.*, 1994). And, in fact, H<sub>2</sub>O<sub>2</sub> was finally detected in 2003 (Encrenaz *et al.*, 2003, 2004; Clancy *et al.*, 2004). There were no known dust storms during these observations. The observed abundance of H<sub>2</sub>O<sub>2</sub> was found to vary between 20 and 40 parts per billion by volume over the planet (Encrenaz *et al.*, 2004), in reasonable agreement with photochemical models that correspond to the time of observation (southern spring,  $L_s = 206^\circ$ ). For other times, the model predictions are for a substantially lower abundance of H<sub>2</sub>O<sub>2</sub> (Atreya and Gu, 1995). Meanwhile, H<sub>2</sub>O<sub>2</sub> in the surface is estimated to be between 1 parts per million (Zent and McKay, 1994) to approximately 250 parts per million (Mancinelli, 1989) on the basis of the reactivity of the surface measured by the Viking Gas Exchange experiment. Thus the H<sub>2</sub>O<sub>2</sub> abundance measured in the atmosphere or that predicted by photochemical models is too small to scrub organics from the martian surface, even after accounting for diffusion of H<sub>2</sub>O<sub>2</sub> gas from the atmosphere on to the surface. Diffusion is a relatively slow process, with a typical time constant of 10–100 days, whereas the lifetime of H<sub>2</sub>O<sub>2</sub> is on the order of only 2 days. Interestingly, laboratory studies also show that, even with 100–1,000 times greater H<sub>2</sub>O<sub>2</sub> abundance, the surface may not be self-sterilizing (Mancinelli, 1989). The implication of the above discussion is that a substantially greater abundance of H<sub>2</sub>O<sub>2</sub> or another oxidant than that produced by photochemistry is needed to account for the lack of detection of organics in the martian surface.

Here, we investigate a new mechanism for producing H<sub>2</sub>O<sub>2</sub> on Mars—chemistry triggered by large-scale electric fields presumed to form in

martian dust devils and storms, as well as in normal saltation, the process by which larger sand particles are moved by the wind and bounce on the surface, ejecting smaller dust particles into the air. These fields are created by contact electrification, or “triboelectric” charging at the grain level, which is generated by collisions between dust and sand particles in martian dust devils and storms, and in normal saltation. Previously, Mills (1977) detected glow discharge while agitating dry powders at low pressures (0.1–6 torr) in an attempt to simulate martian dust storms and surmised that chemical effects were the mechanism by which the glow discharge came about and oxidants such as  $\text{H}_2\text{O}_2$  were produced. It is now known from terrestrial analogs and simulations that convective dust storms can separate charged grains resulting in a large-scale electrostatic dipolar-like field, which on Mars can approach the ambient breakdown field strengths of  $\geq 20$  kV/m (Delory *et al.*, 2006). Schmidt and Schmidt (1998) showed that even larger electric fields occur a few centimeters above the surface during normal saltation. Thus, we expect that the martian electrostatic fields typically approach the breakdown value of about 20 kV/m during dust events.

In this paper, we present an electrochemical model for the production of  $\text{H}_2\text{O}_2$  induced by the electrostatic fields generated in the martian dust devils and storms. The model assumes the production rates of the  $\text{CO}/\text{O}^-$  and  $\text{OH}/\text{H}^-$  pairs from electric fields, calculated by Delory *et al.* (2006) using a collisional plasma physics model.

## MATERIALS AND METHODS

To investigate the consequence of dust devils and dust storms on the distribution of molecules in the atmosphere of Mars, we have developed a new one-dimensional chemical model, based on the photochemical model by Wong *et al.* (2003, 2005). The model solves for each chemical species the steady-state continuity-diffusion equations. The atmospheric density is calculated assuming hydrostatic equilibrium. Concentration of  $\text{CO}_2$  at any given altitude is held fixed. The solar flux, temperature profile, pressure (5.13 mbar at the surface), eddy diffusion coefficients, and water content ( $1.5 \times 10^{-4}$  volume mixing ratio, or  $\sim 10$  pr- $\mu\text{m}$ , at the surface, where pr- $\mu\text{m}$  represents “precipitable micron,” and 1 pr- $\mu\text{m} = 10^{-4}$  g/cm<sup>2</sup> of  $\text{H}_2\text{O} = 3.35 \times 10^{18}$ /cm<sup>2</sup> of  $\text{H}_2\text{O}$  mole-

cules, or approximately 15 ppm  $\text{H}_2\text{O}$ -vapor by volume for uniformly mixed water vapor) are for typical, seasonal, and diurnal average conditions (Atreya and Gu, 1994; Wong *et al.*, 2003, 2005). Dust optical depth is taken as 0.4 for normal, non-dusty conditions (Atreya and Gu, 1994). Condensation of  $\text{H}_2\text{O}$  and  $\text{H}_2\text{O}_2$  are considered. Photochemical reactions together with rates for the normal atmosphere are listed in Wong *et al.* (2003).

During martian dust devils and dust storms, pairs of  $\text{CO}/\text{O}^-$  and  $\text{OH}/\text{H}^-$  are created via electron dissociative attachments:

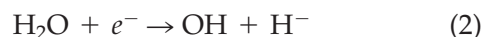

Important electrophotochemical pathways for Mars are illustrated in Fig. 1.

The negative ions,  $\text{O}^-$  and  $\text{H}^-$ , are neutralized mainly by photodetachment ( $\text{X}^- + h\nu \rightarrow \text{X} + e^-$ ), as well as by associative detachment ( $\text{X}^- + \text{Y} \rightarrow \text{XY} + e^-$ ) processes. Photodetachment is an efficient process. Because of its importance in stellar atmospheres, photodetachment of  $\text{H}^-$  in particular has been studied in detail. A relatively large photodetachment cross section of  $1\text{--}5 \times 10^{-17}$  cm<sup>2</sup> for  $\text{H}^-$  has been found over a wide wavelength range of 200–1,800 nm, with an average

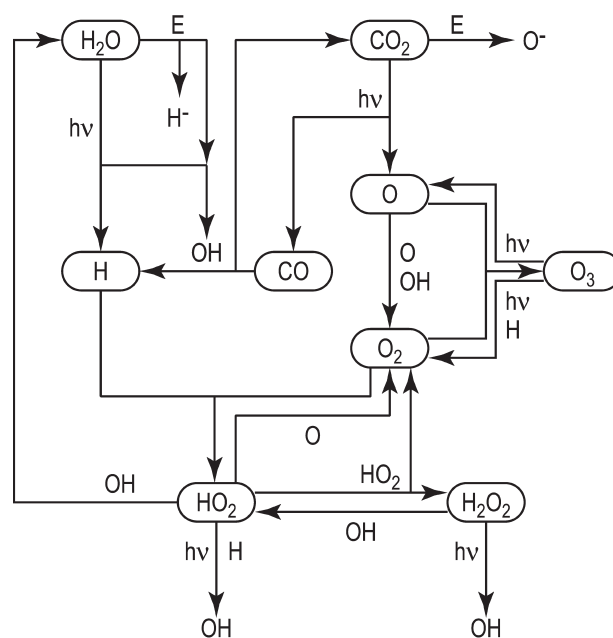

FIG. 1. Electrophotochemical scheme of the martian atmosphere.

value of  $2 \times 10^{-17} \text{ cm}^2$  (Bates, 1978). With an average photon flux of approximately  $2 \times 10^{14} \text{ cm}^{-2}/\text{s}/\text{nm}$  over the relevant range, the photodetachment rate turns out to be 4/s.  $\text{O}^-$  is expected to have similar values, as the process does not depend on the nature of the ion ( $X^-$ ) involved. The photon flux that reaches the surface during dust events may be reduced by factors of approximately  $7 \times 10^{-3}$ – $5 \times 10^{-5}$  for dust optical depth of 5–10. This would reduce the photodetachment rate to approximately  $3 \times 10^{-2}$ – $2 \times 10^{-4}/\text{s}$ , which is fairly robust for neutralization of the negative ions. With the diffusely scattered photon flux included, the rate would be even greater.

The  $\text{CO}/\text{O}^-$  and  $\text{OH}/\text{H}^-$  production rates were obtained by Delory *et al.* (2006), who used a numerical model to solve for electron energization in the tenuous martian atmosphere under the influence of an electric field. In this approach, electric fields between 5 and 25 kV/m are assumed to be produced by macroscopic charge separation occurring in martian dust devils due to triboelectric processes as observed in terrestrial measurements (Farrell *et al.*, 2004), laboratory studies (Eden and Vonnegut, 1973), and simulations (Melnik and Parrot, 1998). An ambient core population of electrons is accelerated by these fields, as described by the Boltzmann equation, utilizing collisional cross sections for vibrational and electronic excitations, dissociative attachment, and impact ionization with  $\text{CO}_2$ . Solutions for the electron energy distribution were obtained as a function of increasing electric field, which resulted in populations that deviated significantly from standard thermal Maxwellian forms. In the presence of water vapor, energized electrons in the 5–12 eV range possess a peak in the cross section for electron dissociative attachment, which

produced  $\text{OH}/\text{H}^-$ . As the electric field increases, so does the number density of electrons with these energies, which results in the  $\text{OH}/\text{H}^-$  production rates shown in Table 1.

In our model, we investigate the importance of the above processes and find that the additional OH produced in Reaction 2, in particular, has a significant effect on subsequent neutral chemistry of the atmosphere. We include this additional source of OH due to electric fields in dust devils and storms in our electrochemical model. For each electric field strength, we assume a rate of OH production at the surface that is equal to the maximum calculated by Delory *et al.* (2006) and listed in Table 1. Above the surface and up to 60 km, the OH production rate profile follows the height profile of water vapor, since OH is a product of dissociation of water vapor. Above this altitude, dust devils and dust storms do not produce significant electrification. However, it is important to stress that the OH production from electrochemistry occurs predominantly close to the surface where the water vapor abundance is greatest, with some contribution from below the  $\text{H}_2\text{O}$  condensation level, which is approximately 20 km for typical thermal profile and water vapor mixing ratio but dependent on local time and season. The calculated OH column density at various field strengths is listed in Table 1.

We have also investigated the effect of electron dissociation of  $\text{H}_2\text{O}_2$ :

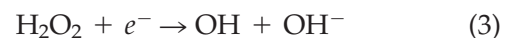

but found the rate of loss of  $\text{H}_2\text{O}_2$  to be much smaller than its production rate.

TABLE 1. EFFECT OF TRIBOELECTRIC FIELD ON OH AND  $\text{H}_2\text{O}_2$

Electric field (kV/m)	OH production rate with electric field ( $\text{cm}^{-3} \text{ s}^{-1}$ ) <sup>a</sup>	Total column density ( $\text{cm}^{-2}$ ) <sup>b</sup>		$\text{H}_2\text{O}_2$ enhancement factor
		OH	$\text{H}_2\text{O}_2$ vapor	
0	0	$7.6 \times 10^{11}$	$3.2 \times 10^{15}$	1
5	$1.31 \times 10^1$	$7.6 \times 10^{11}$	$3.2 \times 10^{15}$	1
10	$3.17 \times 10^3$	$7.6 \times 10^{11}$	$3.6 \times 10^{15}$	1.1
16	$3.27 \times 10^4$	$7.9 \times 10^{11}$	$7.2 \times 10^{15}$	2.3
20	$6.24 \times 10^5$	$1.3 \times 10^{12}$	$6.6 \times 10^{16}$	21
>20	$\sim 7 \times 10^7$	$8 \times 10^{13}$	$7 \times 10^{17}$	220

<sup>a</sup>Delory *et al.* (2006).

<sup>b</sup>After accounting for saturation when applicable. Calculations represent steady-state condition with 10 pr- $\mu\text{m}$   $\text{H}_2\text{O}$ .

## RESULTS

The principal consequence of the above electrochemistry is that the additional OH radical increases the production rate of H, primarily through the following reaction:

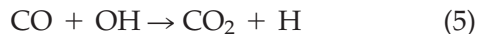

which in turn increases the production rate of H<sub>2</sub>O<sub>2</sub> through the usual reactions:



followed by:



On the other hand, additional OH increases the destruction rate of HO<sub>2</sub> and H<sub>2</sub>O<sub>2</sub>. However, the net result is that OH produced by electric fields may enhance the H<sub>2</sub>O<sub>2</sub> column abundance. For large electric fields, the H<sub>2</sub>O<sub>2</sub> column abundance may be enhanced by a factor of 200 or more beyond the abundance that is produced by photochemistry. As the electric field increases and more OH radicals are produced, the concentration of H<sub>2</sub>O<sub>2</sub> at certain altitudes exceeds its saturation

value, which causes H<sub>2</sub>O<sub>2</sub> to condense and eventually precipitate out of the atmosphere. In Fig. 2, we compare the model concentration profiles of OH and H<sub>2</sub>O<sub>2</sub> in a high electric field case and in the absence of electric field. The resulting column abundance of H<sub>2</sub>O<sub>2</sub> in the gas phase is listed in Table 1 and shown in Fig. 3. All densities in Table 1 and Figs. 2 and 3 are given after accounting for saturation in H<sub>2</sub>O and H<sub>2</sub>O<sub>2</sub>.

## DISCUSSION

Electrification in dust devils and dust storms results in the dissociation of molecules near the surface of Mars, making it far more effective than photolysis, which is more efficient higher in the atmosphere. The most dramatic chemical change is in the large production rate of H<sub>2</sub>O<sub>2</sub>. This is due to the fact that the ultimate source of H<sub>2</sub>O<sub>2</sub> is water vapor whose maximum amount, which is near the surface, is available for breakdown by electric fields. Because of saturation, a much smaller amount of water vapor is available in the photochemical production regime of H<sub>2</sub>O<sub>2</sub>, which lies two to three scale heights above the surface. For large fields, H<sub>2</sub>O<sub>2</sub> becomes supersaturated at

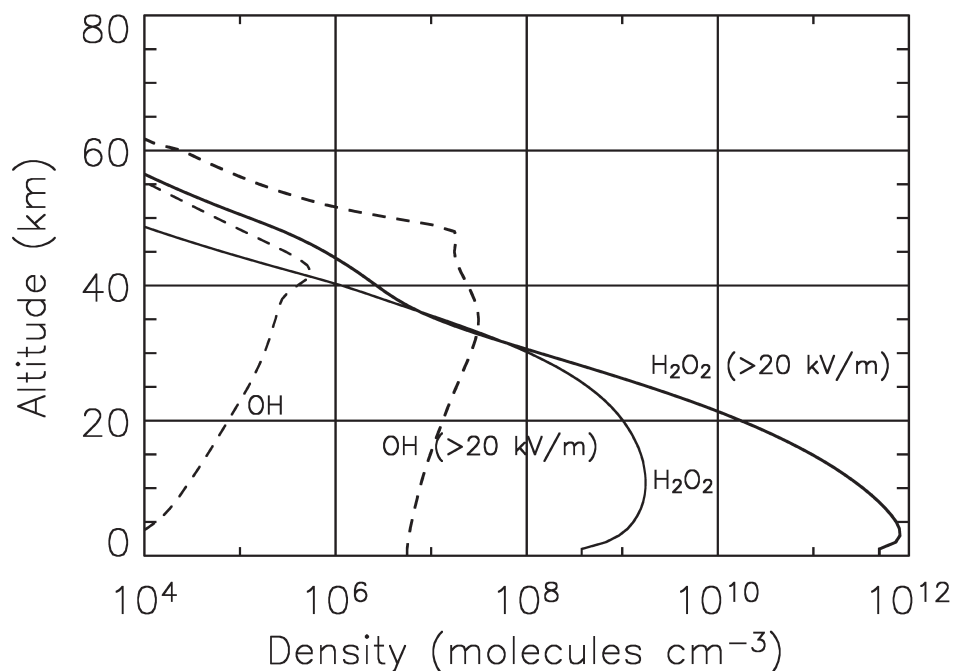

FIG. 2. Comparison of concentration profiles of OH (broken line) and H<sub>2</sub>O<sub>2</sub> (solid line) with and without electrostatic fields due to dust devils and storms. Densities shown are after accounting for saturation of condensibles (H<sub>2</sub>O and H<sub>2</sub>O<sub>2</sub>) when applicable.



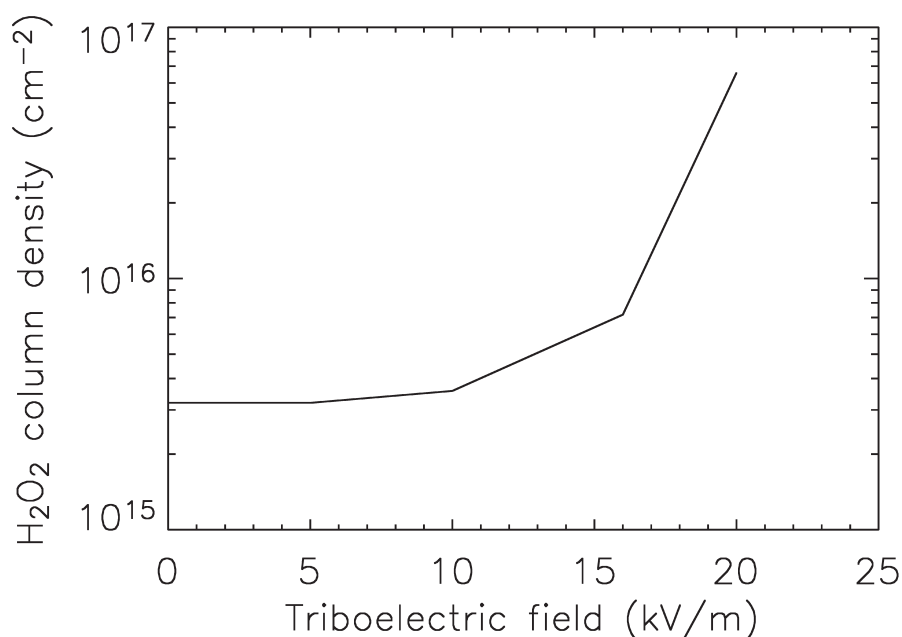

FIG. 3. Column abundance of H<sub>2</sub>O<sub>2</sub> with varying electrostatic fields. Densities shown are after accounting for saturation of condensibles (H<sub>2</sub>O and H<sub>2</sub>O<sub>2</sub>) when applicable.

some altitude in the atmosphere. This occurs with all fields in excess of 10 kV/m, but with fields  $\geq 20$  kV/m the effect is dramatic, as the H<sub>2</sub>O<sub>2</sub> “vapor” abundance in the atmosphere can exceed 200 times that produced by photochemistry alone. In fact, the calculated H<sub>2</sub>O<sub>2</sub> mixing ratio in the atmosphere due to electrochemistry reaches values between 50 and 100 parts per million by volume ( $5 \times 10^{-5}$ – $1 \times 10^{-4}$ ), which is of the same order as that implied by the surface reactivity measured by the Viking gas exchange experiment. Following diffusion into the soil, the amounts are expected to be even greater because of the possibility of accumulation due to the relatively long lifetime of H<sub>2</sub>O<sub>2</sub> in the surface. An important consideration is that diffusion of H<sub>2</sub>O<sub>2</sub> from the atmosphere into the regolith is expected to be rapid, as the electrochemical production of H<sub>2</sub>O<sub>2</sub> occurs close to the surface, which is in contrast to the normal photochemistry case where diffusion times from the production region in the middle atmosphere are typically 10–100 days. Despite the large electrochemical production of H<sub>2</sub>O<sub>2</sub>, its mixing ratio for a typical thermal profile is saturation limited to a maximum value of  $\sim 4$  parts per million ( $4 \times 10^{-6}$ ) in the “gas” phase, or approximately 200 times the observed photochemical value. The excess H<sub>2</sub>O<sub>2</sub> would then condense as ice and precipitate out of the atmosphere as

H<sub>2</sub>O<sub>2</sub> “dust,” using the suspended dust particles as cloud condensation nuclei. This H<sub>2</sub>O<sub>2</sub> dust would eventually settle on to the surface of Mars. Adsorbed onto the airborne dust particles and eventually bound to the regolith material, H<sub>2</sub>O<sub>2</sub> could persist for a much longer time than the 2-day lifetime the H<sub>2</sub>O<sub>2</sub> vapor has against photochemical destruction in the atmosphere.

The adsorption properties of H<sub>2</sub>O<sub>2</sub> condensate on dust nuclei (cloud condensation nuclei), together with its rates of diffusive mixing and sedimentation in dust storms and dust devils, would determine the amount of H<sub>2</sub>O<sub>2</sub> delivered to the surface without being re-evaporated along the way. Although none of these quantities has been quantified satisfactorily, especially in electric storms, it is important to note that the excess H<sub>2</sub>O<sub>2</sub> production due to electrostatic fields occurs very close to the surface. Therefore re-evaporation of H<sub>2</sub>O<sub>2</sub> condensate before reaching the surface is not expected to be a major issue. Moreover, the adsorbed H<sub>2</sub>O<sub>2</sub> ice may be further “protected” as it gets coated itself with the ambient dust particles, similar to the process of coating of the ammonia ice particles of the topmost cloud layer of Jupiter and Saturn by the hydrocarbon haze from above, preventing the spectral identification of these clouds (Atreya *et al.*, 2005). Even if the H<sub>2</sub>O<sub>2</sub> ice did sublimate, the vapor is

expected to diffuse readily into the regolith, as the electrochemical production occurs close to the surface, unlike photochemistry, which occurs several scale heights above it. Depending on the efficacy of heterogeneous catalytic destruction of  $\text{H}_2\text{O}_2$  in the soil,  $\text{H}_2\text{O}_2$  would penetrate to a certain depth before extinction. Bullock *et al.* (1994) have calculated that, with an  $\text{H}_2\text{O}_2$  surface concentration of  $30 \text{ nmol/cm}^3$ , the extinction depth is 1.5 cm, and the lifetime of  $\text{H}_2\text{O}_2$  is 4.3 terrestrial years. However, Viking found reactive soils under rocks, which implies that the oxidant is present at deeper levels. With a lifetime of  $10^5$  years, the extinction depth would be 2.3 m, and a surface concentration nearly 10 times greater. Thus it is evident that once  $\text{H}_2\text{O}_2$  diffuses into the regolith, its lifetime could be relatively long. This is an advantage for the surface organic destruction problem, as  $\text{H}_2\text{O}_2$  lasts only for approximately 2 days in the atmosphere—not long enough to affect the survivability of organics. Note also that  $\text{H}_2\text{O}_2$  is soluble in water, and would be leached from the surface by any tran-

sient liquid flows and thereby carried deeply into the regolith. Thus a wet regolith in contact with a highly oxidizing surface could be bad for survival of intact organics below the surface.

In the surface,  $\text{H}_2\text{O}_2$  could serve as a strong oxidizer, capable of scavenging organic material. It could also help shorten the lifetime of methane gas in the martian atmosphere by accelerating its loss to the surface. If correct, this would imply that a larger source than previously estimated is required to replenish methane, assuming that methane is permanently present on Mars. Depending on the residence time of  $\text{H}_2\text{O}_2$  in the surface, there is also a possibility of  $\text{H}_2\text{O}_2$  undergoing further processing into even more effective superoxides. This would place an even greater burden on the source of methane, in addition to removing other surface organics more efficiently. Laboratory studies on the ultimate fate of  $\text{H}_2\text{O}_2$  in the martian regolith are presently lacking.

The electrically induced production of  $\text{H}_2\text{O}_2$  is expected to be non-uniform over Mars, depending upon the location and distribution of the

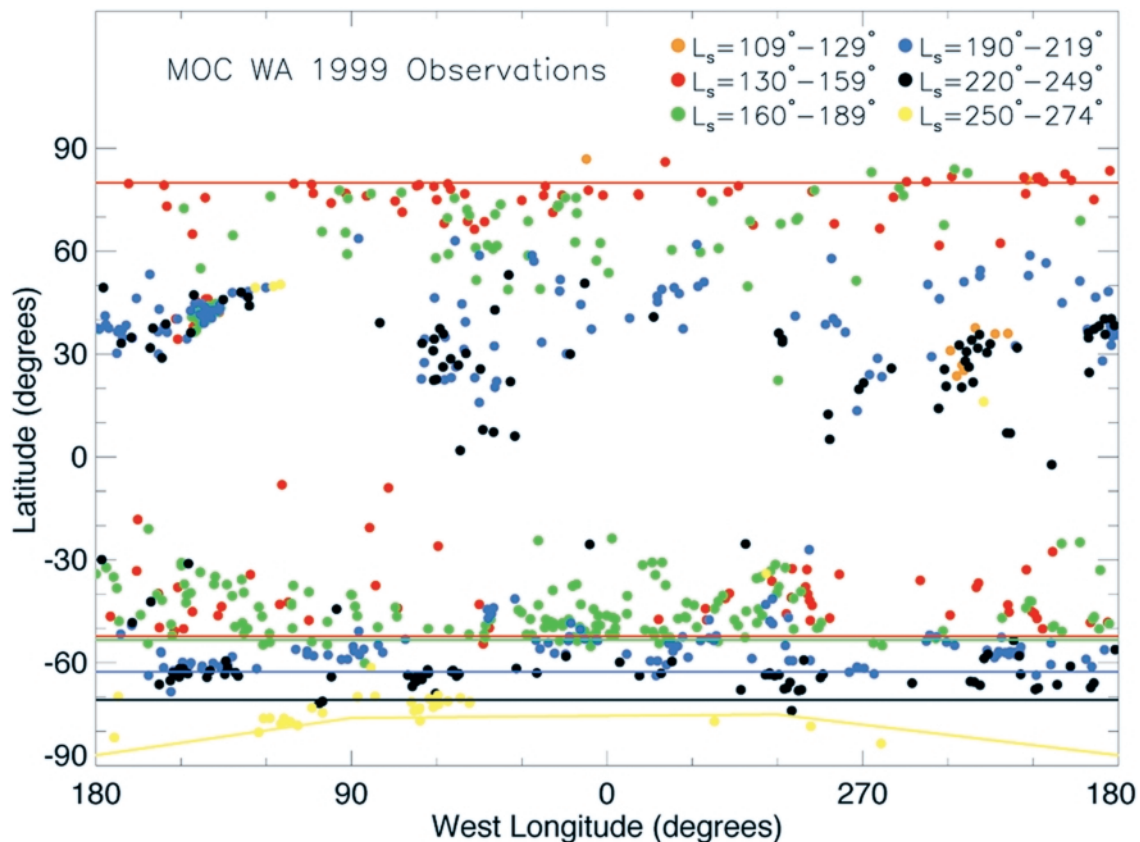

FIG. 4. Temporal and spatial distribution of dust storms observed by the Mars Orbiter Camera (MOC) Wide Angle (WA) mode in 1999 as a function of  $L_s$ . Reprinted from Cantor *et al.* (2001).

martian dust devils and storms and also of  $\text{H}_2\text{O}$ . Similar non-uniformity is expected for  $\text{H}_2\text{O}_2$  produced in the normal saltation process. Both dust devils and convective dust storms play an important role in the martian dust cycle (Zurek *et al.*, 1992; Martin and Zurek, 1993; Cantor *et al.*, 2001; Ferri *et al.*, 2003; Fisher *et al.*, 2005). Theory and observations show that dust devil activity peaks during local summer (Renno *et al.*, 1998, 2000, 2004; Fisher *et al.*, 2005). Observations show that dust devil activity is well correlated with the product of surface heat flux with thermodynamic efficiency, as predicted by the heat engine theory (Renno *et al.*, 1998; Toigo *et al.*, 2003; Fisher *et al.*, 2005). Dust devils are particularly active near albedo boundaries and in lowlands near the boundary of large topographical features (Renno *et al.*, 1998, 2000; Balme *et al.*, 2004; Fisher *et al.*, 2005). Martian dust devils appear to be most active in the Amazonis (25–45°N, 145–165°W) and Causius (45–65°N, 255–285°W) regions (Toigo *et al.*, 2003; Fisher *et al.*, 2005). These are also the regions where the largest (diameters in excess of

500 m) and tallest (more than 8 km) dust devils are observed.

Spacecraft data show that thousands of local and regional martian dust storms occur per year (Cantor *et al.*, 2001). Dust storm activity peaks during the southern hemisphere spring and summer (Figs. 4 and 5). The largest regional and global dust storms form during this period ( $L_s \sim 150\text{--}340^\circ$ ), referred to as the “martian dust storm season” (Martin and Zurek, 1993). This is also the season in which the atmospheric dust opacity reaches maximum values. In general, dust storms are most active in regions of large albedo, terrain elevation, and temperature gradients (Cantor *et al.*, 2001). This is consistent with the prediction of the heat engine model for convective vortices (Renno *et al.*, 1998, 2000).

During the northern early summer ( $L_s \sim 110\text{--}130^\circ$ ) most dust storms occur northwest of Olympus Mons (40°N, 142°W), on the Arcadia-Amazonis border (Fig. 4). In this region, dust storm activity peaks during late summer and early fall ( $L_s \sim 190\text{--}220^\circ$ ). At this time, dust storms

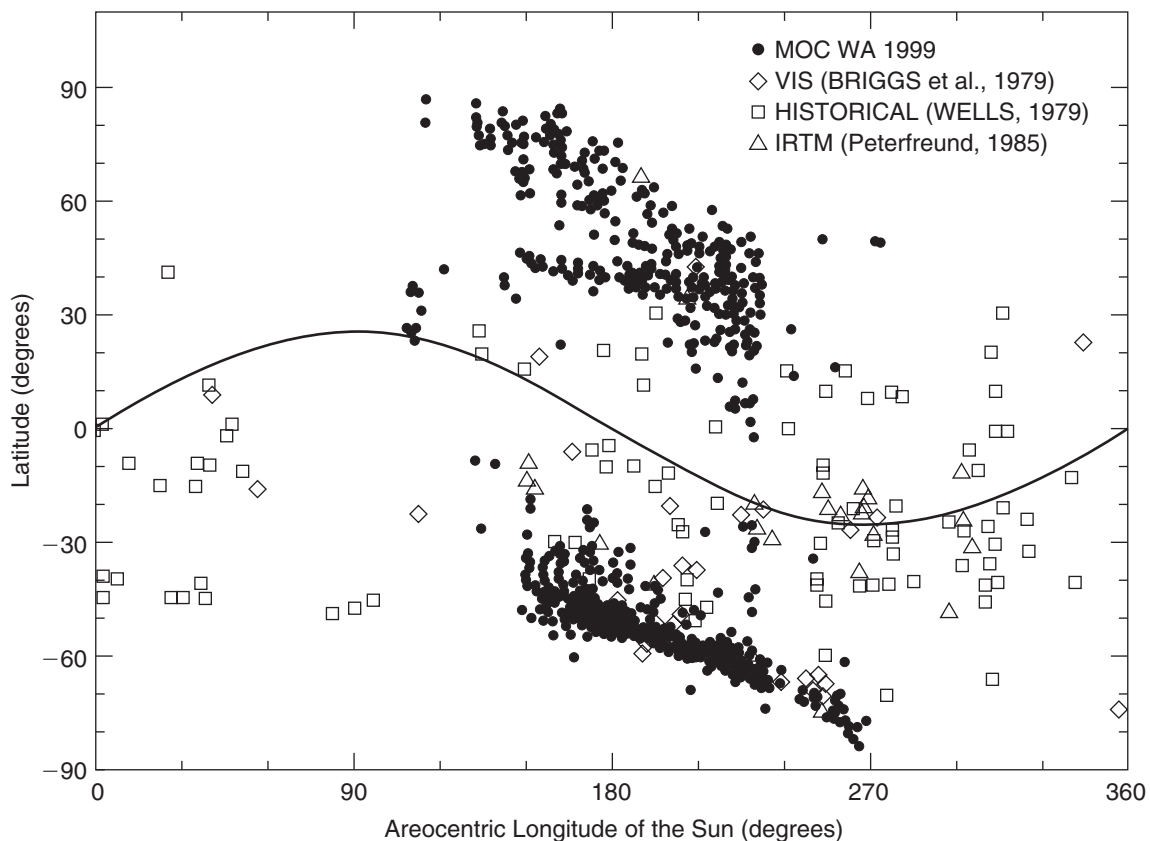

**FIG. 5.** Latitudinal distribution of dust storms as a function of  $L_s$ . Solid line represents subsolar latitude. Reprinted from Cantor *et al.* (2001). VIS, Viking Imaging Subsystem; IRTM (Viking) Infrared Thermal Mapper.



also frequently occur near the edge of the polar cap and extend as far south as Acidalia and Utopia (Cantor *et al.*, 2001). During the southern hemisphere early spring ( $L_s \sim 160\text{--}190^\circ$ ), dust storms form at the edge of the polar cap (Figs. 4 and 5). Dust storms continue to form at the edge of the polar cap during the entire spring season. At the end of the spring, dust storms are more frequent in the southern hemisphere, in the Aonia ( $60^\circ\text{S}, 95^\circ\text{W}$ ) and Sirenum Terra ( $40^\circ\text{S}, 160^\circ\text{W}$ ) regions (Cantor *et al.*, 2001).

An important consideration for this study is the aggregate effect of electrochemistry on oxidant production on Mars. Since the fractional area covered by dust devils during active days is only  $\sim 10^{-4}$  (Ferri *et al.*, 2003), their contribution to the “global”  $\text{H}_2\text{O}_2$  budget is expected to be smaller than that due to photochemistry. On the other hand, the  $\text{H}_2\text{O}_2$  abundance locally can greatly exceed that due to the photochemical source where the dust devils occur, as discussed above. The situation is, however, quite different in dust storms. As mentioned previously, thousands of local and regional martian dust storms occur each year. The active portion of dust storms during their season can cover more than a few percent area of the planet. The electric field produced by dust storms is proportional to their depth and exceeds the breakdown value of  $\sim 25$  kV/m even in a shallow 1-km-deep dust storm. Thus, we expect the electric field of  $\sim 25$  kV/m to be present in the active part of most dust storms. This is also the field used for illustrating maximum  $\text{H}_2\text{O}_2$  production due to electrochemistry in this paper. Since dust storms can cover large areas, they are expected to be a significant contributor to the global  $\text{H}_2\text{O}_2$  budget while they are active.

While the above discussion on the distribution of martian dust devils and storms might imply that, in the present epoch, certain regions of Mars may be more likely than others for detecting chemical effects of storm-generated electric fields and only a few percent of the fractional area of Mars may be affected, two factors—lifetime of  $\text{H}_2\text{O}_2$  in the regolith and the changing boundaries of dust devils and storms over longer time scales—are likely to alter the above conclusion of coverage of electrochemically produced  $\text{H}_2\text{O}_2$ . As we presented previously, the lifetime of  $\text{H}_2\text{O}_2$  in the soil can be very long, ranging from several years to several thousand years. While a longer lifetime would permit larger concentrations to accumulate to deeper levels, climatological changes

could result in relocation and alteration of dust activity that would tend to make electrochemically produced  $\text{H}_2\text{O}_2$  somewhat more widely distributed over the planet. Clearly, more research is needed before this can be proven with certainty.

Finally, there is a good likelihood that the electrochemical production of oxidants is more commonplace and widespread than just during periods and locations of the dust storms and dust devils. The process is “normal” wind-blown saltation, even when there are no storms and the production of  $\text{H}_2\text{O}_2$  proceeds by identical electrochemistry. Schmidt and Schmidt (1998) measured the electric field a few centimeters above the surface during saltation on Earth. Their measurements show electric fields that increase sharply toward the surface, reaching values in excess of 100 kV/m at about 1.5 cm above the surface. This sharp increase is due to the occurrence of charge separation and large densities of charged dust/sand particles in the near-surface layer containing saltating particles (saltation layer). This observation suggests that, on Mars, the near-surface electric field is limited by the atmospheric breakdown value of  $\sim 25$  kV/m. Thus, we should expect the near-surface electric field to be  $\sim 25$  kV/m whenever saltation occurs on Mars. Since saltation is ubiquitous on Mars, we expect the electrochemical production of  $\text{H}_2\text{O}_2$  close to the surface also to be widespread, far greater than the 0.01% area covered by the oxidant produced in dust devils and several percent in dust storms, averaged over the martian year.

## CONCLUSION AND IMPLICATIONS

Ubiquitous aeolian processes—that are expected to result in large electric fields, glow discharges, and surface oxidants—together with harmful ultraviolet radiation that reaches the surface through a thin atmosphere would render the surface of Mars inhospitable to *life as we know it*, now and in the past. Surface oxidants that result from chemistry induced by electrostatic fields produced in martian dust storms and dust devils, as well as during normal saltation, may be responsible for the lack of organics on the surface of Mars. Such surface oxidants may also result in a more rapid removal of methane from the atmosphere than is possible by photochemistry alone. An efficient surface sink would require a

larger flux of methane to explain the observations. This could give additional insight into the source of methane on Mars. However, laboratory data are presently lacking for a complete evaluation of the role of electrochemistry in the martian atmosphere.

Laboratory studies on the nature and strength of electrostatic fields, and possible formation of H<sub>2</sub>O<sub>2</sub> and/or other oxidants induced by such fields would be valuable. Measurements of possible heterogeneous effects, residence time of H<sub>2</sub>O<sub>2</sub> in the surface, diffusion properties of H<sub>2</sub>O<sub>2</sub> into the interior, and its effect on the thermodynamic properties of water/ice and chemical kinetics of destruction of organic material and methane gas by oxidants in the regolith are also recommended. At the same time, additional modeling is warranted to study, in particular, the electrochemical effect on other martian constituents such as ozone and the condensation, sedimentation, and heterogeneous loss of H<sub>2</sub>O<sub>2</sub>. To observe the enhancement of oxidants in dust storms and devils, we may have to wait for *in situ* measurements. This is due to the fact that ground-based infrared observations are not capable of measuring the H<sub>2</sub>O<sub>2</sub> column abundance down to the surface during times of dust activity, whereas submillimeter observations, being global or hemispherical averages, cannot detect localized phenomena. However, the 2009 Mars Science Laboratory will carry instruments as part of its Analytical Laboratory that are designed to search for organics and oxidants, among other things, in the surface, rock, and the atmospheric samples. The Tunable Laser Spectrometer and the Gas Chromatograph Mass Spectrometer of the Sample Analysis at Mars Suite are specifically suited to perform these measurements also during periods of dust storms and when a dust devil passes by, so that it will be possible to monitor chemical changes on Mars due to electrostatic fields associated with dust activity and normal saltation throughout 1 martian year or longer (Mahaffy *et al.*, 2005; Webster *et al.*, 2005; Atreya *et al.*, 2006).

#### ACKNOWLEDGMENTS

S.K.A.'s research was sponsored by NASA's Jet Propulsion Laboratory for his participation as a U.S. Investigator on ESA's Mars Express Mission, Mars Science Laboratory, and the Planetary Atmospheres Program of NASA for the develop-

ment of a generalized numerical code. N.O.R. was partially supported by the Phoenix Mars Scout mission, the Mars Science Laboratory, and the Division of Physical Meteorology of the National Science Foundation.

#### REFERENCES

- Atreya, S.K. (2005) Methane, organics, and related trace constituents on Mars: sources, sinks, implications. *Bull. Am. Astron. Soc.* 37, 669.
- Atreya, S.K. and Gu, Z. (1994) Stability of the Martian atmosphere: is heterogeneous catalysis essential? *J. Geophys. Res.* 99, 13133–13145.
- Atreya, S.K., and Gu, Z. (1995) Photochemistry and stability of the atmosphere of Mars. *Adv. Space Res.* 16, 57–68.
- Atreya, S.K. and Wong, A.S. (2004) Methane on Mars—origin, loss, implications for extinct or extant life [ED13D-0745]. In *AGU Fall Meeting*, American Geophysical Union, Washington, DC.
- Atreya, S.K., Encrenaz, Th., Formisano, V., and Wong, A.S. (2004) Methane on Mars: sources, sinks, and implications for life. Presented at the International Mars Conference, held in Ischia, Italy.
- Atreya, S.K., Wong, A.S., Owen, T.C., Wong, M.H., and Baines, K.H. (2005) Jupiter's ammonia clouds—localized or ubiquitous? *Planet. Space Sci.* 53, 498–508.
- Atreya, S.K., Mahaffy, P.R., and Wong, A.S. (2006) Methane and related trace species on Mars—origin, loss, implications for life, and habitability. *Planet. Space Sci.* (in press).
- Balme, M.R., Whelley, P.L., and Greeley, R. (2003) Dust devil track survey in Argyre Planitia and Hellas Basin. *J. Geophys. Res.* 108, article number 5086.
- Bates, D.R. (1978) Other men's flowers—classical treatment of collisions; Massey's adiabatic criterion and ionization in flames; ion-molecule reactions; bound-free and free-free transitions of electrons in ambient atomic-hydrogen. *Phys. Rep.* 35, 305–372.
- Briggs, G.A., Baum, W.A., and Barnes, J. (1979) Viking Orbiter imaging observations of dust in the Martian atmosphere. *J. Geophys. Res.*, 84, 2795–2820.
- Bullock, M.A., Stoker, C.R., McKay, C.P., and Zent, A.P. (1994) A coupled soil-atmosphere model of H<sub>2</sub>O<sub>2</sub> on Mars. *Icarus* 107, 142–154.
- Cantor, B.A., James, P.B., Caplinger, M., and Wolff, M.J. (2001) Martian dust storms: 1999 Mars Orbiter Camera observations. *J. Geophys. Res.* 106, 23653–23687.
- Clancy, R.T., Sandor, B.J., and Moriarty-Schieven, G.H. (2004) A measurement of the 362 GHz absorption line of Mars atmospheric H<sub>2</sub>O<sub>2</sub>. *Icarus* 168, 116–121.
- Cronin, J.R., Pizzarello, S., and Cruikshank, D.P. (1988) Organic matter in carbonaceous chondrites, planetary satellites, asteroids, and comets. In *Meteorites and the Early Solar System*, edited by J. J. Kerridge and M.S. Matthews, University of Arizona Press, Tucson, pp. 819–857.

- Delory, G.T., Farrell, W.M., Atreya, S.K., Renno, N.O., Wong, A.-S., Cummer, S.A., Sentman, D.D., Marshall, J.R., Rafkin, S.C.R., and Catling, D.C. (2006) Oxidant enhancement in martian dust devils and storms: storm electric fields and electron dissociative attachment. *Astrobiology* 6, 451–462.
- Eden, H.F. and Vonnegut, B. (1973) Electrical breakdown caused by dust motion in low-pressure atmospheres: considerations for Mars. *Science* 180, 962–963.
- Encrenaz, Th., Bézard, B., Greathouse, T., Lacy, J., Richter, M., Atreya, S.K., and Wong, A.S. (2003) *IAU Circular 8254: Hydrogen Peroxide Detection on Mars*, Central Bureau for Astronomical Telegrams, Cambridge, MA.
- Encrenaz, Th., Bézard, B., Greathouse, T., Richter, M., Lacy, J., Atreya, S.K., Wong, A.S., Lebonnois, S., Lefevre, F., and Forget, F. (2004) Hydrogen peroxide on Mars: spatial distribution and seasonal variations. *Icarus* 170, 424–429.
- Farrell, W.M., Smith, P.H., Delory, G.T., Hillard, G.B., Marshall, J.R., Catling, D., Hecht, M., Tratt, D.M., Renno, N., Desch, M.D., Cummer, S.A., Houser, J.G., and Johnson, B. (2004) Electric and magnetic signatures of dust devils from the 2000–2001 MATADOR desert tests. *J. Geophys. Res.* 109, 1.
- Feldman, W.C., Boynton, W.V., Tokar, R.L., Prettyman, T.H., Gasnault, O., Squyres, S.W., Elphic, R.C., Lawrence, D.J., Lawson, S.L., Maurice, S., McKinney, G.W., Moore, K.R., and Reedy, R.C. (2002) Global distribution of neutrons from Mars: results from Mars Odyssey. *Science* 297, 75–78.
- Ferri, F., Smith, P.H., Lemmon, M., and Renno, N. (2003) Dust devils as observed by Mars Pathfinder. *J. Geophys. Res.* 108, doi:10.1029/2000JE001421.
- Fisher, J.A., Richardson, M.I., Newman, C.E., Szwast, M.A., Graf, C., Basu, S., Ewald, S.P., Toigo, A.D., and Wilson, R.J. (2005) A survey of Martian dust devil activity using Mars Global Surveyor Mars Orbiter Camera images. *J. Geophys. Res.* 110, E03004, doi: 10.1029/2003JE002165.
- Flynn, G. (1996) The delivery of organic matter from asteroids and comets to the early surface of Mars. *Earth Moon Planets* 72, 469–474.
- Formisano, V., Atreya, S.K., Encrenaz, T., Ignatiev, N., and Giuranna, M. (2004) Detection of methane in the atmosphere of Mars. *Science* 306, 1758–1761.
- Krasnopolsky, V.A. (1993) Photochemistry of the Martian atmosphere (mean conditions). *Icarus* 101, 313–332.
- Krasnopolsky, V.A., Maillard, J.P., and Owen, T.C. (2004) Detection of methane in the martian atmosphere: evidence for life? *Icarus* 172, 537–547.
- Mahaffy, P.R., Atreya, S.K., Brinkerhoff, W., Cabane, M., Conrad, P., Gorevan, S., Grotzinger, J., Huntress, W., Jakosky, B., Leshin, L., McKay, C., Ming, D., Morris, R., Owen, T., Pepin, R., Scott, J., Squyres, S., and Webster, C. (2005) Organics and isotopes on the 2009 Mars Science Laboratory [abstract 18.13]. *Bull. Am. Astron. Soc.* 37, 652.
- Mancinelli, R.L. (1989) Peroxides and sensitivities of microorganisms on the surface of Mars. *Adv. Space Res.* 9, 191–195.
- Martin, L.J. and Zurek, R.W. (1993) An analysis of the history of dust storm activity on Mars. *J. Geophys. Res.* 98, 3221–3246.
- Melnik, O. and Parrot, M. (1998) Electrostatic discharge in Martian dust storms. *J. Geophys. Res.* 103, 29107–29118.
- Mills, A.A. (1977) Dust clouds and frictional generation of glow discharges on Mars. *Nature* 268, 614.
- Mumma, M.J., Novak, R.E., diSanti, M.A., Bonev, B.P., and Dello Russo, N. (2004) Detection and mapping of methane and water on Mars [abstract 26.02]. In *DPS Meeting 36*, American Astronomical Society, Washington, DC.
- Nair, H., Allen, M., Anbar, A.D., Yung, Y.L., and Clancy, R.T. (1994) A photochemical model of the Martian atmosphere. *Icarus* 111, 124–150.
- Oyama, V.I., Berdahl, B.J., and Carle, G.C. (1977) Preliminary findings of Viking gas-exchange experiment and a model for Martian surface-chemistry. *Nature* 265, 110–114.
- Peterfreund, A.R. (1985) *Contemporarian aeolian processes on Mars: local dust storms* [Ph.D. thesis], Ariz.ona State University, Tempe.
- Renno, N.O., Burkett, M.L., and Larkin, M.P. (1998) A simple theory for dust devils. *J. Atmos. Sci.* 55, 3244–3252.
- Renno, N.O., Nash, A.A., Lunine, J., and Murphy, J. (2000) Martian and terrestrial dust devils: test of a scaling theory using Pathfinder data. *J. Geophys. Res.* 105, 1859–1865.
- Renno, N.O., Abreu, V.J., Smith, P.H., Hartogenesis, O., Burose, D., De Bruin, H.A.R., Delory, G.T., Farrell, W.M., Parker, M., Watts, C.J., and Gratuza, J. (2004) MATADOR 2002: a pilot field experiment on convective plumes and dust devils. *J. Geophys. Res.* 109, doi:10.1029/2003JE002219.
- Schmidt, D.S. and Schmidt, R.A. (1998) Electrostatic force on saltating sand. *J. Geophys. Res.* 103(D8), 8997–9001.
- Squyres, S.W., Arvidson, R.E., Bell, J.F., Bruckner, J., Cabrol, N.A., Calvin, W., Carr, M.H., Christensen, P.R., Clark, B.C., Crumpler, L., Des Marais, D.J., d’Uston, C., Economou, T., Farmer, J., Farrand, W., Folkner, W., Golombek, M., Gorevan, S., Grant, J.A., Greeley, R., Grotzinger, J., Haskin, L., Herkenhoff, K.E., Hviid, S., Johnson, J., Klingelhofer, G., Knoll, A.H., Landis, G., Lemmon, M., Li, R., Madsen, M.B., Malin, M.C., McLennan, S.M., McSween, H.Y., Ming, D.W., Moersch, J., Morris, R.V., Parker, T., Rice, J.W., Richter, L., Rieder, R., Sims, M., Smith, M., Smith, P., Soderblom, L.A., Sullivan, R., Wanke, H., Wdowiak, T., Wolff, M., and Yen, A. (2004) The Opportunity Rover’s Athena science investigation at Meridiani Planum, Mars. *Science* 306, 1698–1703.
- Toigo, A.D., Richardson, M.I., Ewald, S.P., and Gierasch, P.J. (2003) Numerical simulation of Martian dust devils. *J. Geophys. Res.* 108, 5047, doi:10.1029/2002JE002002.
- Webster, C.R., Mahaffy, P.R., and Atreya, S.K. (2005) Methane, oxides of hydrogen and carbon, and their isotope ratios: significance and measurement on NASA’s 2009 Mars Science Lab (MSL) Mission [abstract 33.15]. *Bull. Am. Astron. Soc.* 37, 694.

- Wells, R.A. (1979) *Geophysics of Mars*, Elsevier Science, New York.
- Wong, A.S., Atreya, S.K., and Encrenaz, Th. (2003) Chemical markers of possible hot spots on Mars. *J. Geophys. Res.* 108, 5026.
- Wong, A.S., Atreya, S.K., and Encrenaz, Th. (2005) Correction and updated reaction. *J. Geophys. Res.* 110, E10002, doi:10.1029/2005JE,002509.
- Zent, A.P. and McKay, C.P. (1994) The chemical reactivity of the martian soil and implications for future missions. *Icarus* 108, 146–147.
- Zurek, R.W., Barnes, J.R., Haberle, R.M., Pollack, J.B., Tillman, J.E., and Leovy, C.B. (1992) Dynamics of the atmosphere of Mars. In *Mars*, edited by H.H. Kieffer, B.M. Jakosky, C.W. Snyder, and M.S. Matthews, University of Arizona Press, Tucson, pp. 835–933.

Address reprint requests to:

*Sushil K. Atreya*  
*Department of Atmospheric, Oceanic, and*  
*Space Sciences*  
*University of Michigan*  
*Ann Arbor, MI 48109-2143*

*E-mail: atreya@umich.edu*