

**Effects of Visual Demand and In-Vehicle Task
Complexity on Driving and Task Performance
as Assessed by Visual Occlusion**

**Omer Tsimhoni, Herbert Yoo,
and Paul Green**



1. Report No. UMTRI-99-37		2. Government Accession No.		3. Recipient's Catalog No.	
4. Title and Subtitle Effects of Visual Demand and In-Vehicle Task Complexity on Driving and Task Performance as Assessed by Visual Occlusion				5. Report Date December, 1999	
				6. Performing Organization Code account 376015	
7. Author(s) Omer Tsimhoni, Herbert Yoo, and Paul Green				8. Performing Organization Report No. UMTRI-99-37	
9. Performing Organization Name and Address The University of Michigan Transportation Research Institute (UMTRI) 2901 Baxter Rd, Ann Arbor, Michigan 48109-2150 USA				10. Work Unit no. (TRAIS)	
				11. Contract or Grant No.	
12. Sponsoring Agency Name and Address Mitsubishi Motors Corporation 1 Nakashinkiri, Hashime-Cho, Okazaki, Aichi, 444-8501, Japan				13. Type of Report and Period Covered 9/97 – 9/99	
				14. Sponsoring Agency Code	
15. Supplementary Notes					
16. Abstract <p>Given the recent proliferation of in-vehicle systems, understanding how drivers deal with the visual demands of driving while operating these systems is essential. To provide such, 16 subjects drove a simulator on roads with long curves of several different radii while providing verbal responses to questions about the content of electronic maps displayed on the center console. In additional sessions, visual demand of the same road segments was measured using the voluntary occlusion technique.</p> <p>Task completion time while driving was correlated with static completion time, generally increasing when the task was performed while driving. It decreased, however, for short tasks, especially when only one glance was made. As driving workload increased, subjects made shorter glances at the display, made more of them, but waited longer between glances. The net effect was a slight decrease in total glance duration (eyes-off-the-road time). As driving workload increased, driving performance became worse.</p> <p>These results suggest a complex interaction in which drivers attempt to compensate for increased visual demand or task complexity, which leads to a statistically and practically significant decline in driving performance with task duration and driving workload.</p>					
17. Key Words Driving, Visual demand, Visual occlusion, Workload, Secondary controls, Map reading, ITS, Human factors, Ergonomics, Safety, Usability			18. Distribution Statement No restrictions. This document is available to the public through the National Technical Information Service, Springfield, Virginia 22161		
19. Security Classify. (of this report) (None)		20. Security Classify. (of this page) (None)		21. No. of pages 72	22. Price

UMTRI Technical Report 99-37
 Omer Tsimhoni, Herbert Yoo,
 and Paul Green

University of Michigan
 Transportation Research Institute
 Ann Arbor, Michigan, USA

1 ISSUES

1. How does task context (driving versus stationary) affect driver performance and behavior for a display-intensive in-vehicle task?
2. How does driving workload affect driver performance and behavior for the in-vehicle task?
3. How do age and gender affect the above?
4. How does the method employed, the voluntary occlusion technique, affect driving performance and is it predictive of glance behavior while performing the in-vehicle display?
5. How does intermittent occlusion of the road-scene affect performance of the in-vehicle task?

2 TEST PLAN

Maps & questions

SHORT TASK

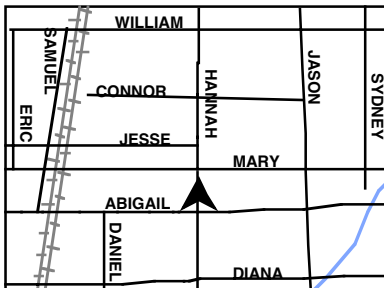

What street are you on?

MEDIUM TASK

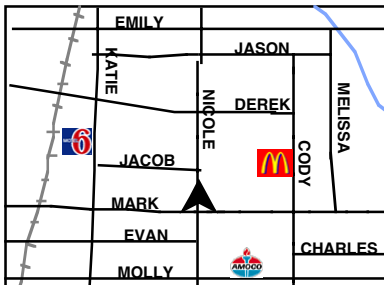

What street is the fast food restaurant on?

LONG TASK

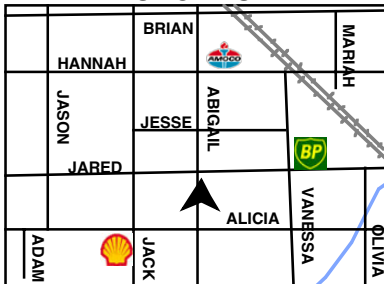

What street intersects with VANESSA at a gas station?

Task: drive simulator on roads with long curves while providing answers to questions about maps (3 levels of task complexity / response duration)

Subjects

	Female	Male
Young (21-30)	4	4
Old (over 65)	4	4



Position of in-vehicle display

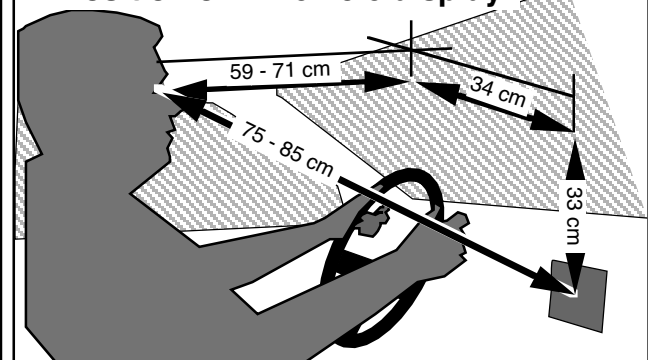

3 RESULTS

A. Glance dependent measures

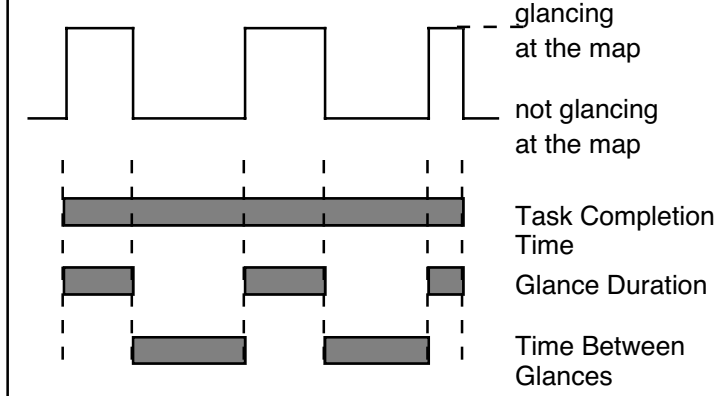

B. The effect of age and gender

Task completion time		Female	Male
Young		3.2±2.2	2.9±2.1
Old		6.1±3.8	7.1±4.5
Mean glance duration		Female	Male
Young		1.3±0.3	1.7±0.6
Old		1.4±0.4	1.5±0.6

C. Task context (driving vs. stationary)

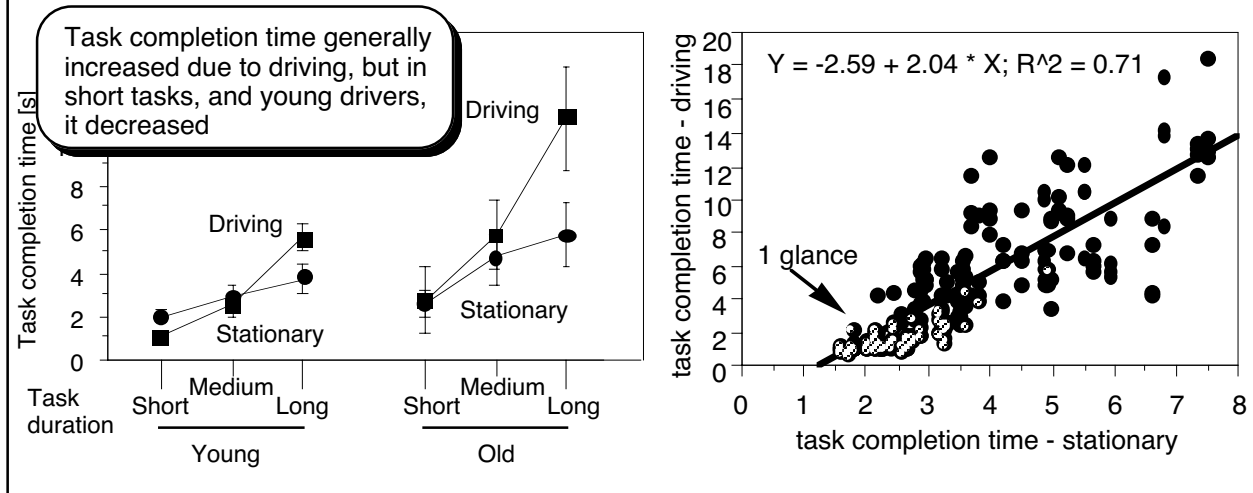

D. Driving workload (road curvature)

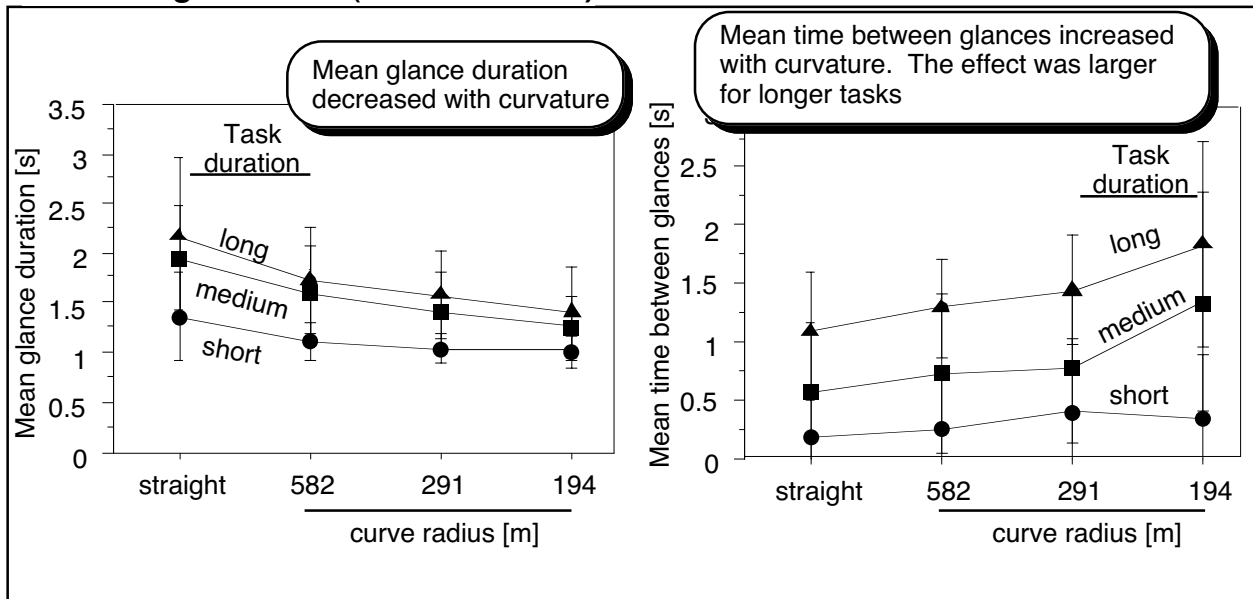

3 RESULTS (CONT.)

E. Voluntary occlusion

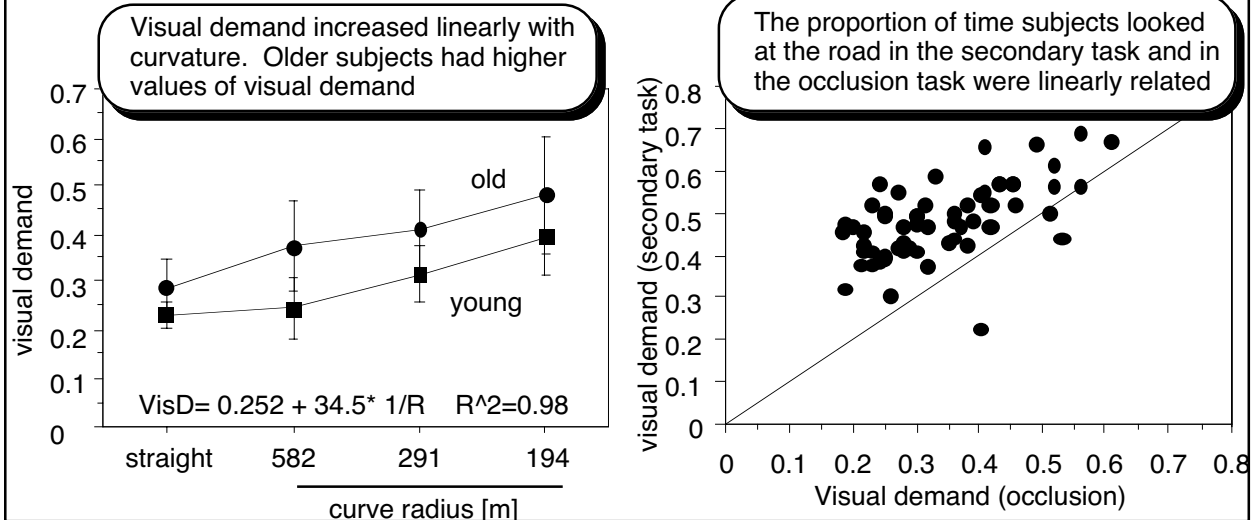

F. Driving performance

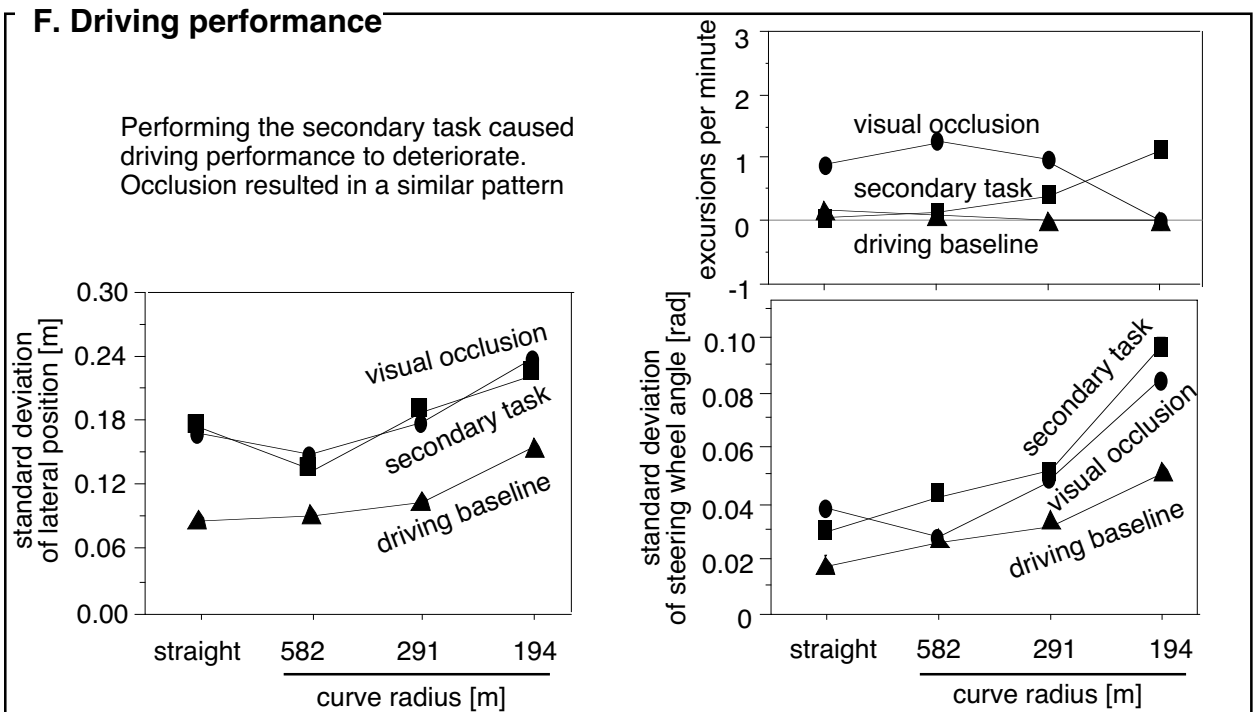

G. Intermittent occlusion of the road scene

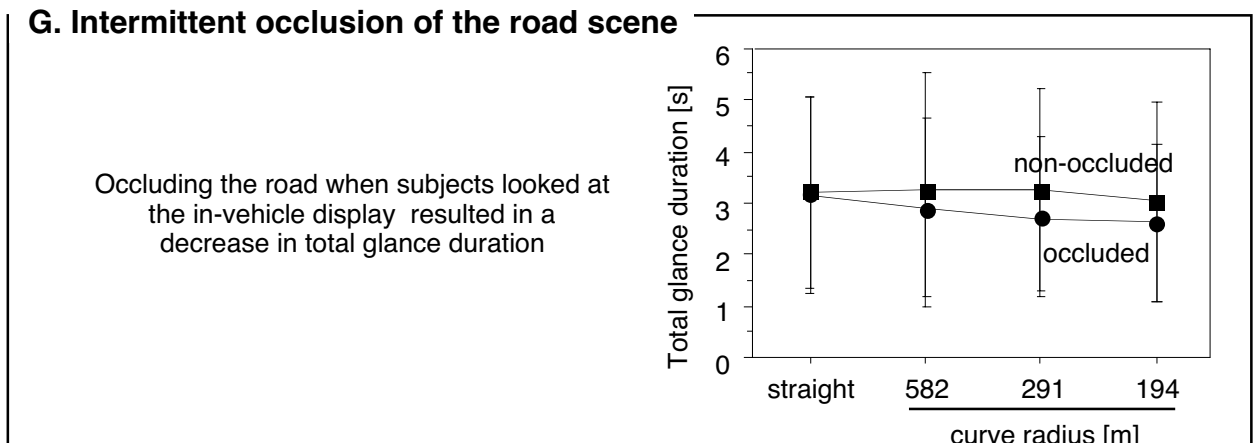

3 RESULTS (CONT.)

H. Subjective ratings

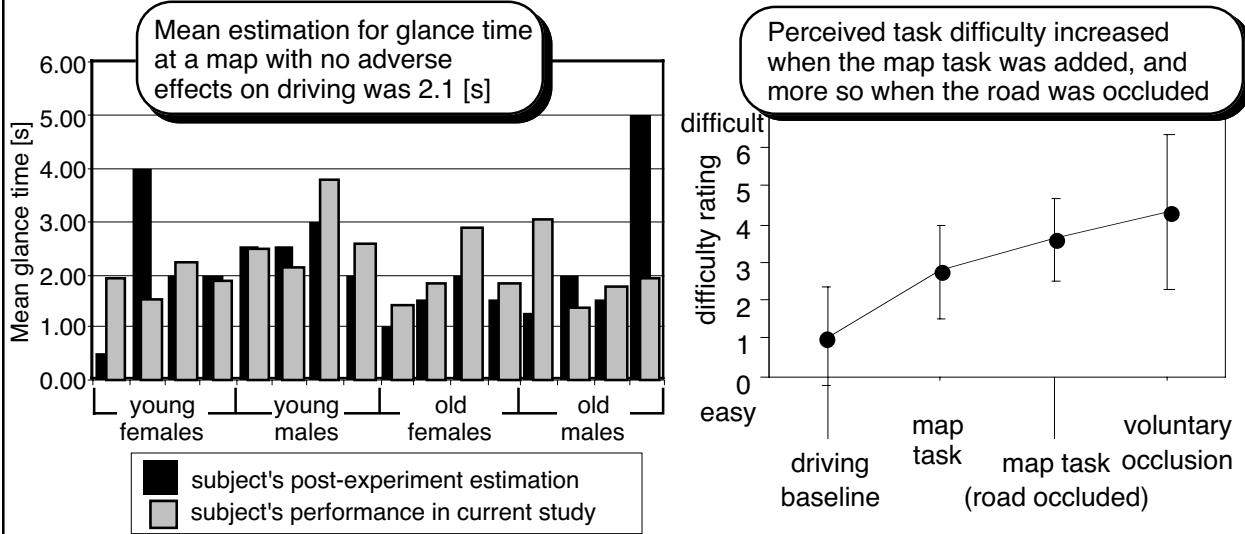

4 CONCLUSIONS

Task context (driving versus stationary)

- Task completion time Increased when performed while driving (but decreased for short tasks)
- Total glance duration remained constant (but decreased for short tasks)

Driving workload (road curvature)

- Task completion time did not change significantly as a function of road curvature
- Mean glance duration decreased and the number of glances increased in sharper curves
- Driving performance declined as curve became sharper

Age and gender

- Older drivers made more glances, their mean time between glances were longer and their task completion times were longer
- The mean glance duration did not vary as a function of age
- Older drivers' driving performance was worse

Voluntary occlusion

- Visual demand, as measured in the visual occlusion technique, predicted glance behavior while performing the in-vehicle task
- The decline in driving performance with occlusion was similar to the decline with the in-vehicle task

Intermittent occlusion of the road scene

- Occluding the road whenever subjects looked at the in-vehicle display resulted in shorter glances
- Task completion time did not change
- Subjects chose to make more efficient glances as a result of the the lack in peripheral input

TABLE OF CONTENTS

INTRODUCTION.....	1
TEST PLAN.....	5
Overview.....	5
Test Participants.....	5
Map-Reading Task.....	5
Simulated Roads.....	8
Test Materials and Equipment.....	9
Test Activities and Sequence.....	13
RESULTS.....	15
Overview.....	15
Glance Behavior.....	16
The Effect of Driving on Glance Behavior.....	17
The Effect of Curvature on Glance Behavior.....	21
The Effect of Occlusion on Glance Behavior.....	24
The Effect of Age and Gender on Glance Behavior.....	26
Voluntary Occlusion.....	27
Visual Demand as a Function of Curvature.....	27
Using Visual Demand Instead of Curvature to Evaluate Performance.....	29
Driving Performance.....	31
Lane Excursions.....	31
Standard Deviation of Lateral Position.....	35
Standard Deviation of Steering Wheel Angle.....	36
Subjective Ratings.....	38
Difficulty.....	38
Safety.....	38
Difficulty of Common Driving Tasks.....	39
Mean Glance Duration.....	41
Simulator Realism.....	42
CONCLUSIONS.....	43
REFERENCES.....	47
APPENDIX A – LIST OF 100 STREET NAMES PRESENTED IN THE MAPS.....	49
APPENDIX B – PRE-TEST BIOGRAPHICAL FORM.....	51
APPENDIX C – CONSENT FORM.....	53
APPENDIX D – DATA COLLECTION SHEET.....	55
APPENDIX E – POST-TEST EVALUATION FORM.....	57
APPENDIX F – FONT SIZE CHOICE FOR STREET NAMES ON MAPS.....	59
APPENDIX G – DATA ANALYSIS.....	61

INTRODUCTION

Over the last few years there has been a proliferation of in-vehicle systems and functions. Climate control systems provide for temperature control for individual occupants. Entertainment systems allow for switching among multiple CDs. Navigation systems, often requiring as much explanation as all previously existing interior features have been added. Thus, drivers are now faced with operating an increasingly complex vehicle. Future projections are for significant increases in the complexity of the driver interface. However, drivers are not becoming more capable at operating these systems and the demands of driving, due to growing congestion, are presenting greater challenges as well.

Therefore, it is essential to begin to understand the demands of driving and how drivers deal with those demands while operating in-vehicle systems. This information can be used to design in-vehicle systems that are easy to operate, that manage information flow to the driver (Michon, 1993), and that identify roads that are excessively demanding to drive.

An important element of any research program concerning in-vehicle systems is some means to define the demands of driving. In the past, this has been done by (1) subjective categorization of workload (e.g., high and low), (2) a variety of measures that characterize driver performance (e.g., standard deviation of lateral position), (3) secondary task (e.g., measuring performance in a loading task), (4) physiological responses (e.g., heart rate variability), or (5) subjective impressions (e.g., ratings of workload). However, few measures have been used consistently across studies and some are only weakly linked to the moment-to-moment demands of driving.

It is obvious to most people that driving is basically a visual task. If one cannot see, one cannot drive. Although there are arguments as to how much of driving is visual (the number 90 percent is often used without support (Sivak 1996)), the basic point is still true. This suggests that a very simple way to measure the demand of driving would be to ask drivers to close their eyes whenever they can, and to use the percentage of time their eyes are open as a measure of the visual demand of driving. Unfortunately, collecting data on eye closure is not easy. An alternative approach is to provide drivers with a device that occludes their vision such as a helmet with a moveable visor or LCD goggles, or in the case of a driving simulator, by employing a device that blocks or grays out the projected image temporarily. The method for actuating the device (foot switch, hand switch, voice) varies with the experiment. The occlusion approach was first proposed by Senders et al. (1967) and has worked extremely well. However, since the original work, there have only been a few studies that have used this approach, and it has largely been forgotten. In part, this is because it is difficult to get permission to conduct experiments on public roads in which drivers are asked to close their eyes. Alternatively, simulators that provide adequate scene fidelity in a cost-effective manner have not existed until recently.

Over the last few years, the Driver Interface Group in the UMTRI Human Factors Division has continued a line of investigation that utilizes the visual occlusion method to assess visual demand. In the first major experiment (Tsimhoni and Green, 1999), 24 subjects drove on a simulated one-lane road while using a cruise control. When they needed to see the road to drive safely, they pressed a footswitch. Across conditions there were 4 curve radii (combined with 3

deflection angles) driven along with straight sections. Figure 1 shows the mean change across subjects in visual demand as curves of various radii are driven. Notice that at approximately 100 m before the beginning of the curve the demand begins to rise, peaking at or just after the beginning of the curve and then trailing off. One of the remarkable features of this method is the ability to assess visual demand almost on a second-by-second basis.

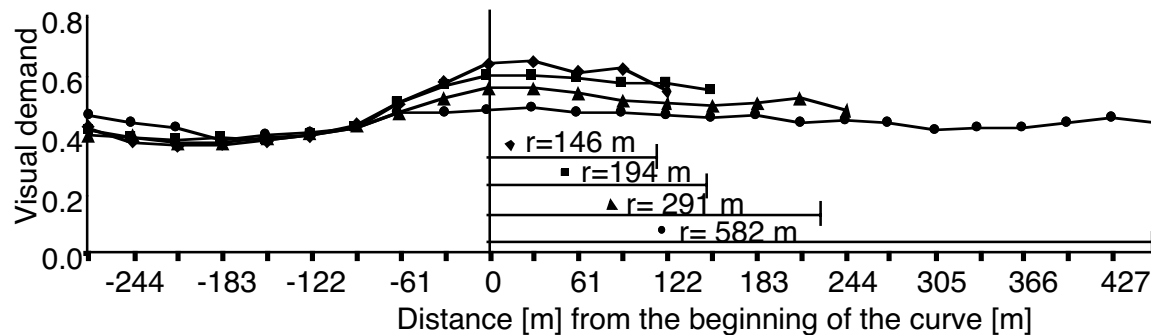

Figure 1. Relationship between position in a curve and visual demand

Figure 2 shows the mean demand levels near the beginning of each curve. Notice how consistently demand changes with curve radius and driver age. Together, these results suggest a measure that is quite sensitive to geometric characteristics that should influence visual demand. A significant advantage of this method is that it provides a means to assign values to the aggregate visual demands that drivers experience, whether they are due to road geometry, traffic, signs, or other factors. This method could be used to equate the driving demands across different roads or different simulators. Unfortunately, the aforementioned experiment did not examine the effect of the occlusion task on driving performance.

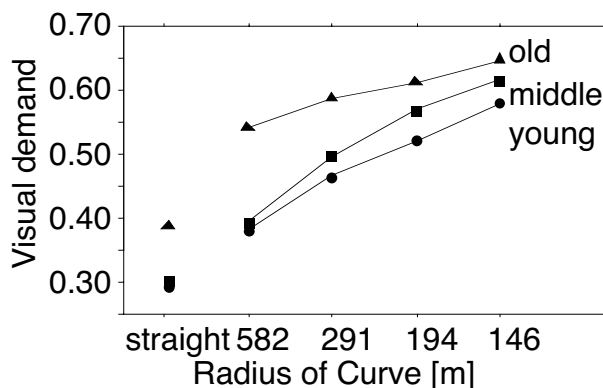

Figure 2. Relationship between visual demand and road curvature

One of the underlying assumptions of this method is that time spent not looking at the road is available for looking elsewhere, and that in looking elsewhere, no information is gained from a peripheral view of the road. That critical assumption of the occlusion method has not been thoroughly examined in the literature so far.

Another key recent development has been the drafting of SAE J2364 (Society of Automotive Engineers, 1999; Green, 1999a,b,c,d) also known as The 15-Second Rule. According to that recommended practice, “Any navigation function that is accessible by the driver while a vehicle is in motion shall have a static total task time of less than 15 seconds.” The rationale for this rule was that the risk of a crash was much greater when drivers did not look at the road, and that the risk increases with the number of glances away from the road and with glance duration. Unfortunately, glance behavior is difficult to measure and the time to reduce eye fixation data is considerable. As an alternative, static task completion time has been proposed. Static task completion time is correlated with both eyes-off-the-road time and dynamic (on-road) task completion time, but is much easier to measure. However, the literature only contained crude estimates of the relationship between these various measures and additional data was desired.

Given these developments, the following questions were explored in a driving simulator:

1. How does *task context (driving versus stationary)* affect driver performance and behavior for a display-intensive in-vehicle task?

SAE J2364, the recommended practice for safety, requires that task times be measured statically. How well do those measurements relate to what happens when people drive?

2. How does *driving workload* affect driver performance and behavior for a display-intensive in-vehicle task?

The correspondence between stationary and while-driving performance could very well depend upon the difficulty of the driving task.

3. How do *age and gender* affect the above?

Age and gender are well known to have significant impacts on human performance. For example, not only does performance decline with age, but the extent of that decline often interacts with the test conditions explored

Measures of interest for the above questions include:

- a) task completion time
- b) measures of glance behavior (total glance time, number of glances, mean glance duration, and mean time between glances)
- c) driving performance (standard deviation of lateral position, excursion rate, standard deviation of steering wheel angle)
- d) ratings of difficulty by the subjects

4. How does the *method employed, the voluntary occlusion technique*, affect driving performance, and is it predictive of glance behavior while using an in-vehicle display?

Occlusion of the road should degrade driving performance, but this point has not been examined before.

5. How does *intermittent occlusion of the road-scene* affect performance of the in-vehicle task?

When performing an in-vehicle task, drivers have been assumed not to obtain any information from the road, an assumption that has not been verified

TEST PLAN

Overview





Subjects drove a simulator on roads with curves of several different radii while performing a secondary task that involved verbal responses to questions about the content of electronic maps. There were three types of questions, grouped by task complexity. Measures of glance behavior, visual demand, and driving performance were collected. In separate additional sessions, the visual demand of road segments was measured using the voluntary occlusion technique.

Test Participants

Sixteen licensed drivers participated in this experiment, 8 younger (21 to 28 years old, mean of 25) and 8 older (66 to 73 years old, mean of 70). Within each age bracket there were 4 men and 4 women. Participants were recruited via an advertisement in the local newspaper, from the UMTRI subject database, and from among friends of the experimenters. All were paid \$35 for their participation.

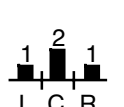
Table 1 summarizes some characteristics of the subjects. They reported driving 3,000 to 23,000 miles per year. (The average for U.S. drivers is about 10,000 miles per year.) Subjects were tested for visual acuity, depth perception, peripheral vision, and color vision. Most subjects had a stereo depth perception of at least 100 s of arc in angle of stereopsis. All subjects had a peripheral vision range of 125 degrees at the minimum. Two young male subjects had color vision deficiency which did not interfere with their ability to drive the simulator or respond to the in-vehicle display.

Table 1. Subject information

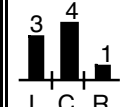
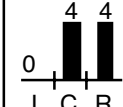
	Young		Old		Young (8)	Old (8)
	Women (4)	Men (4)	Women (4)	Men (4)		
Mean age	26	25	70	70	25	70
Mean years of driving	9	9	48	52	9	50
Mean annual mileage	12,500	13,250	7,250	10,500	12,875	8,875
# of subjects with at least 1 previous simulator study	2	0	4	3	2	7
Range of visual acuity	20/15- 20/25	20/15- 20/22	20/30- 20/50	20/18- 20/40	20/15- 20/25	20/18- 20/50
Lane typically driven on a 3-lane highway: L-Left; C-Center; R-Right						
# of subjects with ≥ 1 accident in the last 5 years	3	2	2	1	5	3

Map-Reading Task

In the map-reading (secondary) task, subjects verbally responded to questions about in-vehicle maps. Answers fell into 3 duration categories (short, medium, long)

(Figure 3). Maximum answer-time limits for each of the questions were specified in order to increase the number of questions presented.

<p>SHORT</p> <p>Question: What street are you on?</p> <p>Answer: HANNAH</p> <p>(Maximum 8 s to answer)</p> <p>Note: Arrowhead indicates current location.</p>	
<p>MEDIUM</p> <p>Question: What street is the fast food restaurant on?</p> <p>Answer: CODY</p> <p>(Maximum 11 s to answer)</p>	
<p>LONG</p> <p>Question: What street intersects with VANESSA at a gas station?</p> <p>Answer: JARED</p> <p>(Maximum 15 s to answer)</p>	

Figure 3. Examples of questions for each task duration (maps shown at 1:2 scale)

Three types of icons (hotels, fast food restaurants, and gas stations, Table 2) likely to be found on real maps, were presented. The three icons in each category were selected because they were (1) well known to American drivers, and (2) readily discriminable from others. The subjects were not required to know the name of the business each icon represented, but they were required to know the category the icon represented.

Table 2. Icons presented in the map displays

Hotels	Fast food restaurants	Gas stations
 Red Roof Inn	 McDonald's	 Shell
 Best Western	 Burger King	 Amoco
 Motel 6	 Taco Bell	 BP

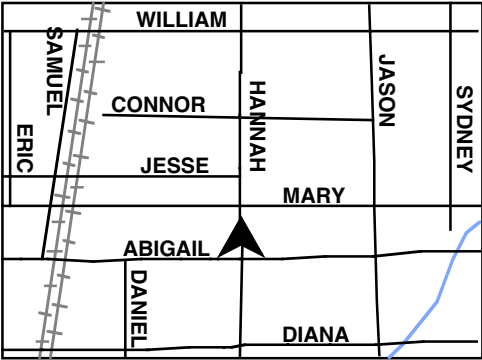
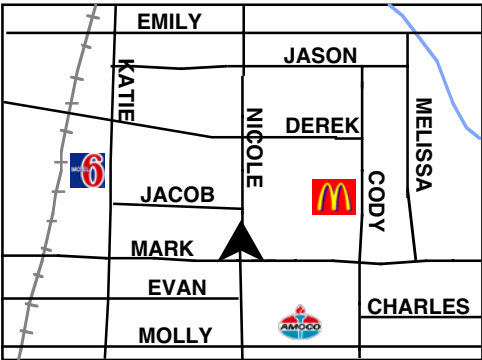
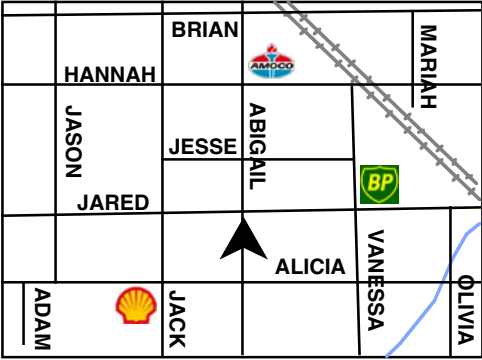
(Note: There was no affiliation with the companies whose logos are shown here.)

These icons did not appear for the short-duration (locate-driven-street) task. The map for medium-duration (locate-icon-street) task had three icons, one from each category. The map for long-duration tasks (locate intersecting street near icon) had three icons from a single category. Exactly 120 distinct maps were used in this experiment. No map was presented to a subject more than once.

Each map consisted of 12 streets (6 horizontal and 6 vertical), one river, and one railroad track, based on what is typical for U.S. maps (George-Maletta, Hunter, Brooks, Lenneman, and Green, 1998). The names used for the streets were taken from a list of 100 most popular baby names (www.babycenter.com/babynames/names98.html) updated to 1998. See Appendix A for the complete list of names used. Uncommon names and those that were not pronounced well by the computer speech-generator were not used. Furthermore, names longer than 7 letters were eliminated to reduce clutter on the map. The maps were 12.7 cm (5 in) tall, 9.5 cm (3.75 in) wide (4:3 aspect ratio), and 15.9 cm (6.25 in) diagonal, approximately the size of contemporary in-vehicle displays. The 16-point font translated to 17 min of visual angle (0.005 radians) (Figure 4). This visual angle was chosen to be consistent with results from Nowakowski and Green (1998), which recommended 14-point text for similar map displays viewed at the same distance. (See Appendix F for a detailed discussion.)

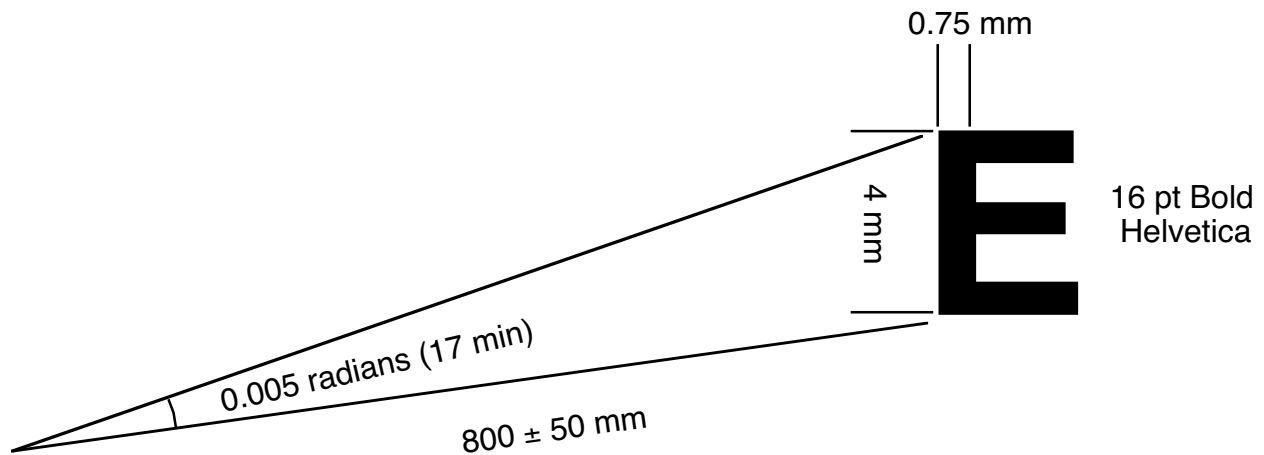

Figure 4. The visual angle and font size used for the in-vehicle display

Simulated Roads

The driving task was designed to include 4 levels of visual workload. Test roads had 1 straight test section and curves with 3 curve radii, connected by short straight sections for which data were not collected. The straight section was assumed to have the lowest visual workload level. The 3 curve radii were chosen based on Tsimhoni and Green (1999), in which a linear relation was found between the mean visual demand and the reciprocal of curve radius. Specifically, a linear increase in visual demand was found for curves of 3, 6, and 9 degrees of curvature (curve radii of 582 m, 291 m, and 194 m, respectively). However, the visual demand within curves was found to be greater at the beginning of curves and to decrease to a steady state after approximately 150 m. Based on these results, the secondary task of this study was initiated 200 m after the beginning of curves and the curves were designed to be long enough for a constant visual demand value to be maintained.

For each level of visual workload, 3 secondary tasks, one of each duration, were presented to the subject in a random order. This translated to approximately 80 s of constant driving workload. In the real world, it would be unlikely to encounter such long, constant-radius curves. Moreover, the sharpest curve, which spanned over 540 degrees, could only be built in a virtual environment.

All lanes of the two-lane road were 3.66 m (12 ft) wide, with left and right curves alternating. See Table 3 for additional information about the road geometry.

Table 3. Description of road

Type	Curve Radius (m)	Length (distance in m)	Time (min:s)	Practice	Test
Start	0	274	0:23	✓	✓
Curve	582	1829	1:31	✓	✓
Transition	0	183	0:10	✓	✓
Curve	291	1829	1:31	✓	✓
Straight	0	1829	1:31	✓	✓
Transition	0	183	0:10	✓	✓
Curve	194	1829	1:31	✓	✓
Transition	0	457	0:23		✓
Curve	582	1829	1:31		✓
Transition	0	183	0:10		✓
Curve	291	1829	1:31		✓
Straight	0	1829	1:31		✓
Transition	0	183	0:10		✓
Curve	194	1829	1:31		✓
Total		16095	13:34		

Note: Driving baseline and occlusion runs had the same pattern but curves were only half the length.

Test Materials and Equipment

This experiment was conducted using the UMTRI Driver Interface Research Simulator, a low-cost driving simulator based on a network of Macintosh computers (Olson and Green, 1997). The simulator consists of an A-to-B pillar mockup of a car, a projection screen, a torque motor connected to the steering wheel, a sound system (to provide engine, drive train, tire, and wind noise), a sub-bass sound system (to provide vibration), a computer system to project images of an instrument panel, and other hardware. The projection screen, offering a horizontal field of view of 33 degrees and a vertical field of view of 23 degrees, was 6 m (20 ft) in front of the driver, effectively at optical infinity.

The electronic maps were displayed on a computer monitor (13 in diagonal Macintosh Color Monitor) at the center console of the simulator. To simulate a small display, cardboard was positioned over the display, allowing only part of it to be seen by the subject. The center of the monitor was positioned 27 ± 2 degrees below the horizontal line of sight and 28 ± 2 degrees to the right of the center (Figure 5 and Figure 6).

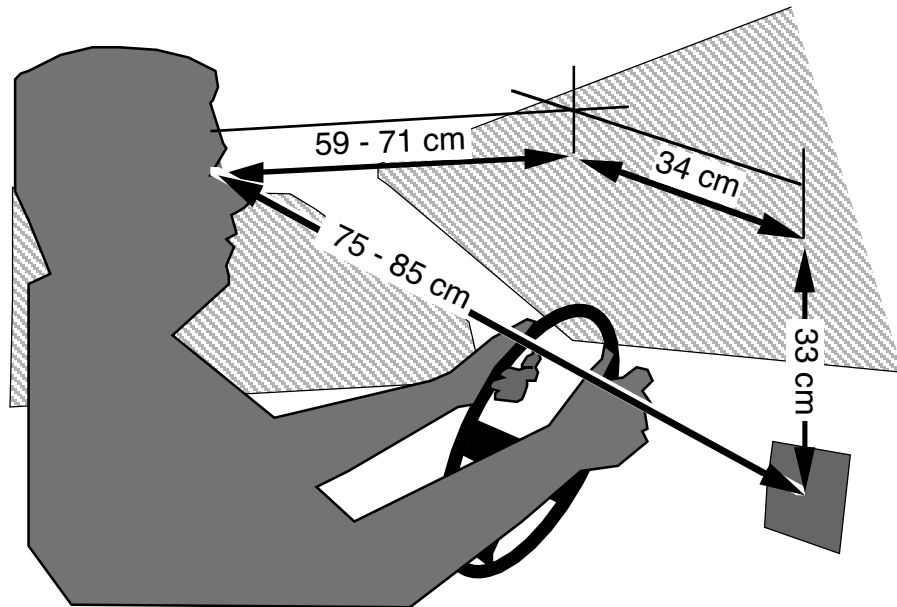

Figure 5. The location of the in-vehicle display



Figure 6. Driver's view of the road and map
(Note: The road and map in this image are enhanced for clarity)

A custom SuperCard program (SuperCard ver. 3.6, IncWell Digital Media Group), running on a Power Macintosh 9500/150, was used to display the electronic maps and to generate the questions via speech using a text-to-speech converter (MacinTalk - Victoria, high quality).

For this experiment, the simulator software was modified to accommodate the voluntary visual occlusion technique. Previously, an LCD shutter had been mounted on the overhead projector to periodically block the projected image (Tsimhoni and Green, 1999). In the new implementation, the scene-image generator was controlled by the simulator software. Whenever the subject pressed a foot switch with the left foot, the simulator displayed a gray screen instead of the road scene for 500 ms and recorded the time the switch was pressed. The luminance levels for the blanked road scene and map were chosen to minimize the dilation and constriction of the pupils. The overall arrangement of equipment at the time the experiment was conducted is shown in Figure 7.

An additional modification to the simulator provided a 2-way serial communication with the secondary computer, which ran a SuperCard program to control the electronic map. The simulator used script files to determine where or when commands should be sent to the secondary computer for each run. The communication protocol with the secondary computer consisted of the start and end of each question interval and of the question to be asked. In addition, there were commands that changed the mode of operation of the secondary program or even disabled it altogether.

The custom SuperCard program on the secondary computer presented the questions to subjects (as text-to-speech output) and then displayed the electronic maps whenever a mouse button on the center console was pressed by the subject. When pressing that button, the secondary program requested the simulator to replace the road scene with a gray field. The road scene reappeared and the map disappeared when the mouse button was released. Thus, the timing of glances at the in-vehicle display (and the number of glances) was collected by recording the state of the mouse button. Equipment for direct recording of eye fixations was not available.

The simulator collected occlusion and driving data at 30 samples per second. For this experiment, the data that was used for analysis included time, road segment number, lateral position, steering wheel angle, and whether the display was visible to the subject or not.

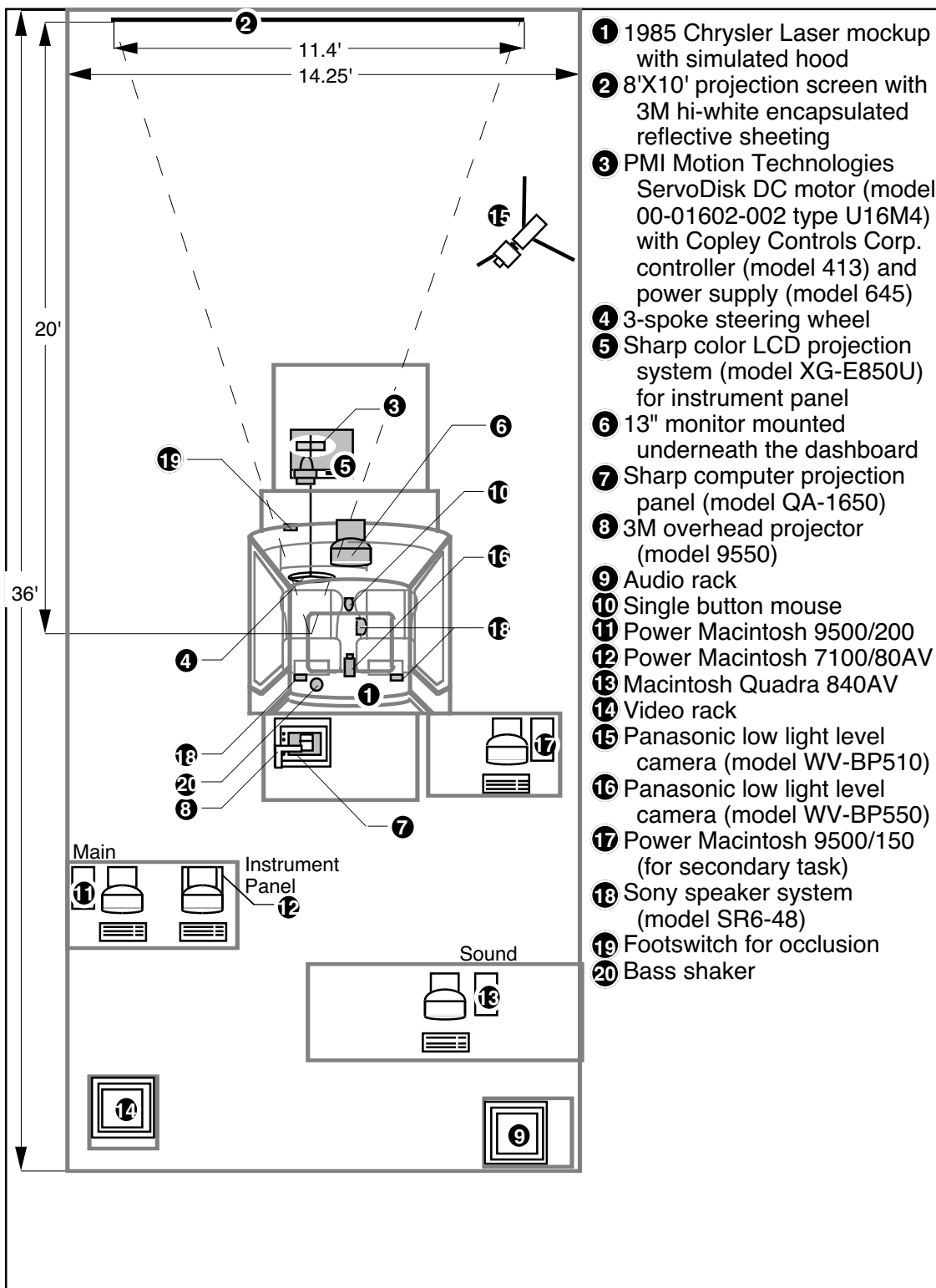

Figure 7. Plan view of UMTRI's Driver Interface Research Simulator

Test Activities and Sequence

The subjects began by completing a biographical form (Appendix B), and a consent form (Appendix C) followed by performing a vision test and then sitting in the driving simulator (Table 4– activity A). (The experimenter’s data collection sheet and the entire experiment protocol can be seen in Appendices D and E.)

Table 4. Summary of activities and their sequence

	Activity	Time (min)	Driving	Occlusion	Secondary task
A	pre-experiment forms and setup	8			
B	training: map-reading task	16	stationary		24 maps
C	map-reading task baseline	5	stationary		12 maps
D	training: driving	5	driving		none
E	driving baseline	16	driving		
F	training: driving and map-reading	8	driving	occluded	12 maps
G	driving and map-reading task	16	driving	occluded	24 maps
H	driving and map-reading task	16	driving	non- occluded	24 maps
I	break	5			
J	driving and map-reading task	16	driving	occluded	24 maps
K	map-reading task baseline	5	stationary		12 maps
L	training: driving with occlusion	10	driving	occluded	none
M	driving with occlusion	16	driving	occluded	none
N	post-experiment forms	8			
	Total	150			

The subjects were then provided with a list of all the street names that they would hear throughout the experiment. At that time, the computer read the names to them using the same voice they would hear in test trials.

After the subjects said they could recognize all the names (by listening to them and by reading them), the experimenter showed icons to subjects and described the categories to which they belonged. To check that the icons were remembered, subjects then named the vendor for each icon. If they did not recognize an icon, the experimenter helped them memorize it (e.g., “notice that the icon of the Red Roof Inn is red and looks like a slanted roof”). Finally, the icons were shuffled and the subject was requested to point to all the restaurants, all the gas stations, and all the fast-food restaurants.

Before starting the actual training sessions, the subjects were shown 3 cards, one for each question. Each card had a color printout of the map as it would appear on the display. In addition, the corresponding question was printed at the bottom of the card. The experimenter explained the question and verified that the subject responded correctly. For the long questions (name the intersecting street near an icon), several examples were given until the experimenter felt confident that the subject understood the task (Table 4 – activity B).

The subjects were provided with two training sessions of the map-reading task, after which the baseline data for the map-reading task was collected (Table 4 – activity C). Then the subjects were given a training session of driving the simulator, and baseline data of driving was collected (Table 4 – activities D and E).

Training for the combined driving and map-reading task was provided. In this combined task, subjects were presented with three questions, with 3 expected task durations (short, medium, and long), for each curve radii and for the long stretch of straight road. The order of the questions was randomized (Table 4 – activity F).

The data for the combined task were collected under two test conditions: occluded and non-occluded. In the occluded condition, the road scene blanked out whenever the subject displayed the electronic map. In the non-occluded condition, the road was continuously visible even when the subject displayed the electronic map. Since the purpose of this condition was to determine if information about lane position was being processed peripherally, subjects were instructed not to look at the road when the mouse was pressed. Most subjects were able to perform this task without difficulty. This set of activities was followed by a baseline of map-reading without driving. The subjects were given a 5-minute break within this set of runs (Table 4 – activities G-K).

Two training sessions of driving with voluntary occlusion were provided. Then the subjects drove the same road as they did with the first combined driving and map-reading task with voluntary occlusion (Table 4 – activities L, M).

Next, subjects filled out a questionnaire (Appendix E) followed by a short debriefing session about their written responses. The subjects were then paid and thanked (Table 4 – activity N).

RESULTS

Overview

The results section consists of 6 subsections: (1) this overview, (2) a brief summary of the data analysis procedure, and 4 subsections that analyze the following data: (3) glance behavior, (4) voluntary occlusion data, (5) driving performance, and (6) subjective ratings. Table 5 lists the conditions, effects, and dependent measures that were examined in each of the subsections.

Table 5. Structure of the results section

	Conditions and effects	Dependent measures
Glance behavior	Driving effect Curvature effect Occlusion effect Age and gender effects	Mean glance duration Number of glances Total glance duration Task completion time Mean time between glances
Voluntary occlusion	Curvature effect	Visual demand
Driving performance	Curvature effect Driving baseline Driving with map Driving with occlusion	Number of lane excursions SD of lateral position SD of steering wheel angle
Subjective ratings	Experimental conditions Common driving tasks Realism of the simulator Prediction of own glance duration	Rating of difficulty Rating of safety

The glance behavior subsection presents the effects of the following factors on glance behavior: (1) the effect of driving, (2) the effect of curvature, (3) the effect of occlusion, and (4) the effect of age and gender. Each of these effects is further subdivided into 5 different measures of glance behavior: (1) the mean glance duration, (2) the number of glances, (3) the total glance duration, (4) the task completion time, and (5) the mean time between glances.

The voluntary occlusion subsection presents the correlation between visual demand and curvature. Furthermore, it shows the advantage in using visual demand instead of curvature to evaluate performance.

The driving performance subsection presents the effect of curvature and of the different settings (driving baseline, driving with map, driving with occlusion) on 3 performance measures: (1) rate of lane excursions, (2) the standard deviation of lateral position, and (3) the standard deviation of steering wheel angle.

The subjective ratings subsection presents data collected at the end of the experiment in the post-experiment forms. It presents what the subjects thought of the difficulty and safety of the different tasks, of the difficulty of common driving tasks, their prediction of mean glance duration, and their rating of the realism of the simulator.

For a detailed discussion of the data analysis procedure, see Appendix G.

Glance Behavior

Five temporal measures of glance behavior of subjects were examined (Table 6 and Figure 8).

Table 6. Definitions of the dependent measures for quantifying glance behavior

Measure	Definition
Task completion time	Time required to complete the task, from the beginning of the first glance at the display to the end of the last glance
Number of glances	Number of glances at the display
Total glance duration	Cumulative time elapsed glancing at the display during all glances
Mean glance duration	$\frac{\text{Total glance duration}}{\text{Number of glances}}$
Mean time between glances	$\frac{\text{Task completion time} - \text{Total glance duration}}{\text{Number of glances} - 1}$ (Number of glances >1)

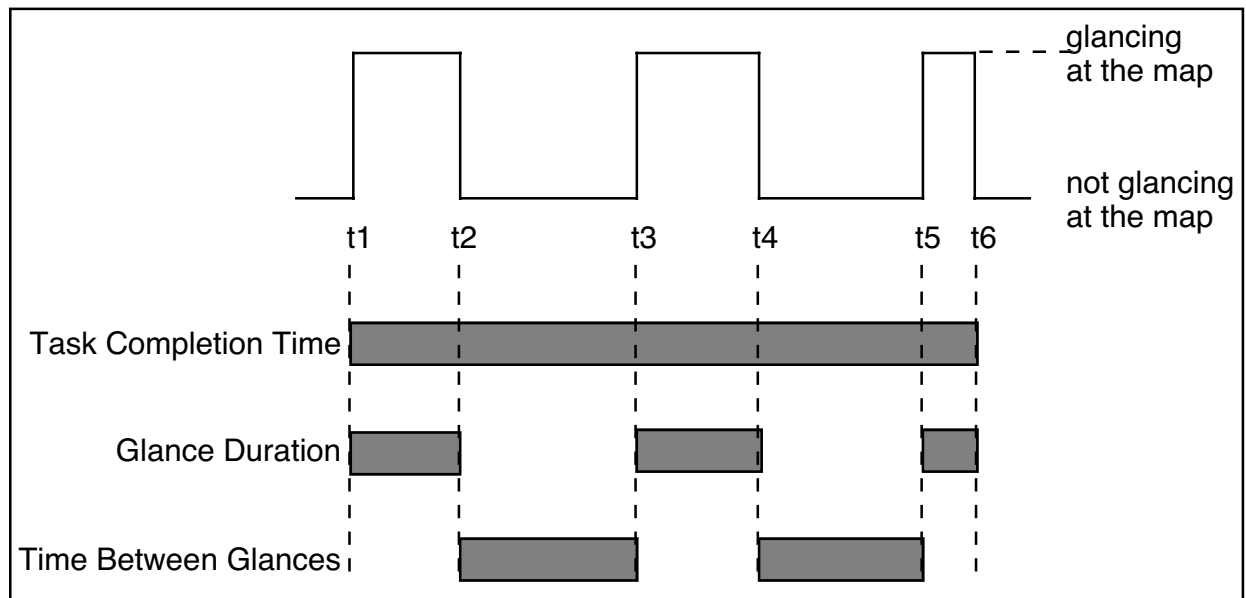

Figure 8. Graphic representation of glance dependent measures

The Effect of Driving on Glance Behavior

Glance behavior in a stationary vehicle was compared with glance behavior while driving the vehicle. This is important because SAE Recommended Practice J2364 assumes that static task time, static total glance time, and eyes-off-the-road time while driving are all linked (Society of Automotive Engineers, 1999; Green, 1999c,d). As mentioned earlier, when the vehicle was stationary, the subjects were instructed to make one glance to the display. In contrast, when they drove the vehicle, they made as many glances as necessary to complete the task while staying in their lane. Since only one glance was made when the vehicle was stationary, there is no value in reporting the mean glance duration (since it equals the total glance duration), the mean time between glances (which was essentially 0), or the number of glances (which was 1). Hence, only the total glance duration and the task completion time are reported here.

The Effect of Driving on Task Completion Time

On average, task completion time was longer while driving than stationary ($p=0.0001$). Figure 9 presents the three-way interaction between the effect of driving, the task duration, and the subject's age ($p=0.0003$).

For most conditions, the task completion time was longer when driving. This was probably due to the workload imposed by the driving task and the transition time spent looking back to the display and to the road. However, this was not true for all the conditions tested. In fact, older subjects completed the short task at the same pace in the driving and stationary conditions whereas younger subjects completed the short task much faster while driving. When people drove, they had a greater pressure to complete the task as soon as possible (i.e., in order to look back at the road). However, when tasks became complicated and required multiple glances, drivers were less likely to compress glance durations.

Age had a significant effect on task completion time ($p=0.0002$). Task completion times for older subjects were longer than those for younger subjects (4300 versus 2900 ms when stationary and 6500 versus 3050 ms when driving). Moreover, the interaction between age and the effect of driving was significant ($p=0.0001$). Older subjects had a larger increase in task completion time due to driving. The three-way interaction between age, driving, and task duration was significant as well ($p=0.003$). The effect of driving on task completion time for older subjects was much larger when the questions were longer.

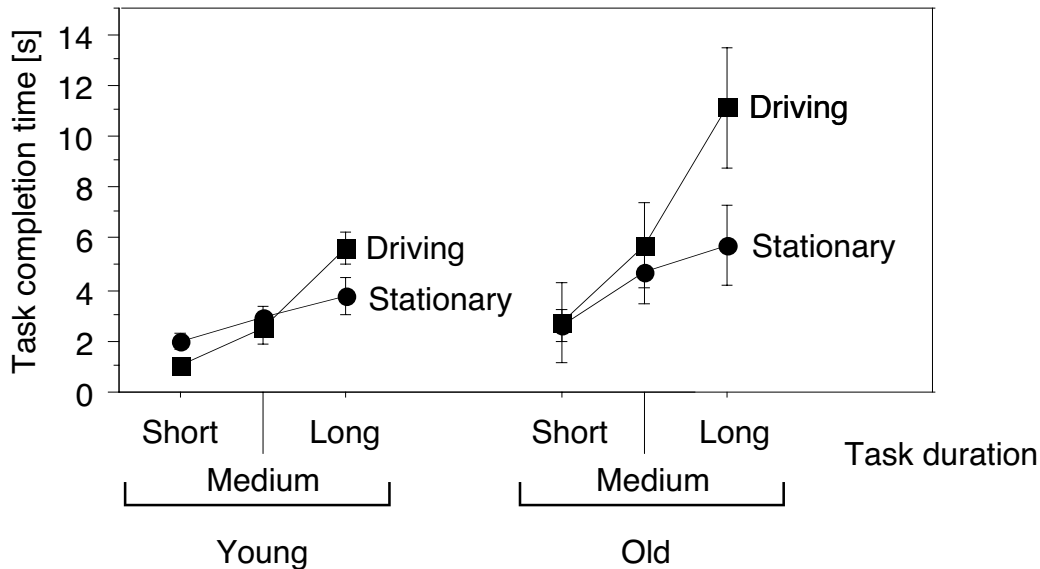

Figure 9. The effect of driving, task duration, and age on task completion time

Task completion time while driving is presented in Figure 10 as a function of task completion time in the stationary condition. A simple linear regression resulted in Equation (1), which also appears at the top of the figure. An additional regression was performed while forcing the intercept to zero. Although it explained less of the variance, it might be more useful for practical purposes. In essence, this regression showed that task completion while driving was 43% higher than while stationary (a ratio of 1.43). However, it is clear from the figure that some of the data had a ratio below 1.0, particularly those cases in which only one glance was made (see Equation 2 and 3).

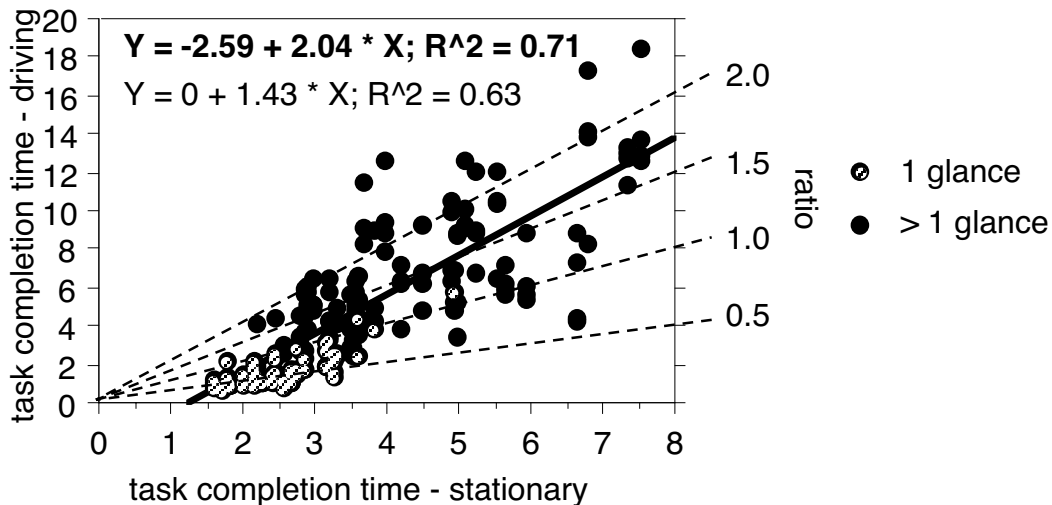

Figure 10. The effect of driving on task completion time

$$\text{All occurrences:} \quad Y = -2.59 + 2.04 * X \quad [Y = 1.43 * X] \quad (1)$$

$$\text{Only 1 glance:} \quad Y = -1.12 + 1.14 * X \quad [Y = 0.71 * X] \quad (2)$$

$$\text{Multiple glances:} \quad Y = -0.56 + 1.69 * X \quad [Y = 1.57 * X] \quad (3)$$

Y – Task Completion Time while Driving
X – Task Completion Time while Stationary

To better understand the effect of driving on task completion time, the frequency distribution of the ratio between driving and stationary was calculated (Figure 11). The mean ratio of all occurrences was 1.2 (Figure 11 a). The data were further stratified into two subsections: (1) one glance, and (2) more than one glance (Figure 11 b and c), When only one glance was made, the mean ratio was 0.66. When multiple glances were made, the mean ratio was 1.55. (It is noted that instead of using number of glances as a stratification criterion, a certain task completion time could have been used. By stratifying all the occurrences for which task completion time was above or below 2.7 s, very similar results to those shown could have been achieved. Since the empirical stratification by number of glances or by glance time does not intend to imply causality, it is only to be used as a rough estimate, either of the stratification criteria may be used.)

Figure 11 d, e, and f presents a partitioning of the multiple glance sessions into the three task duration conditions. While multiple glances for the short task and the medium task resulted in mean ratio values of 1.35 and 1.24, respectively, in the long task, the mean ratio was 1.80.

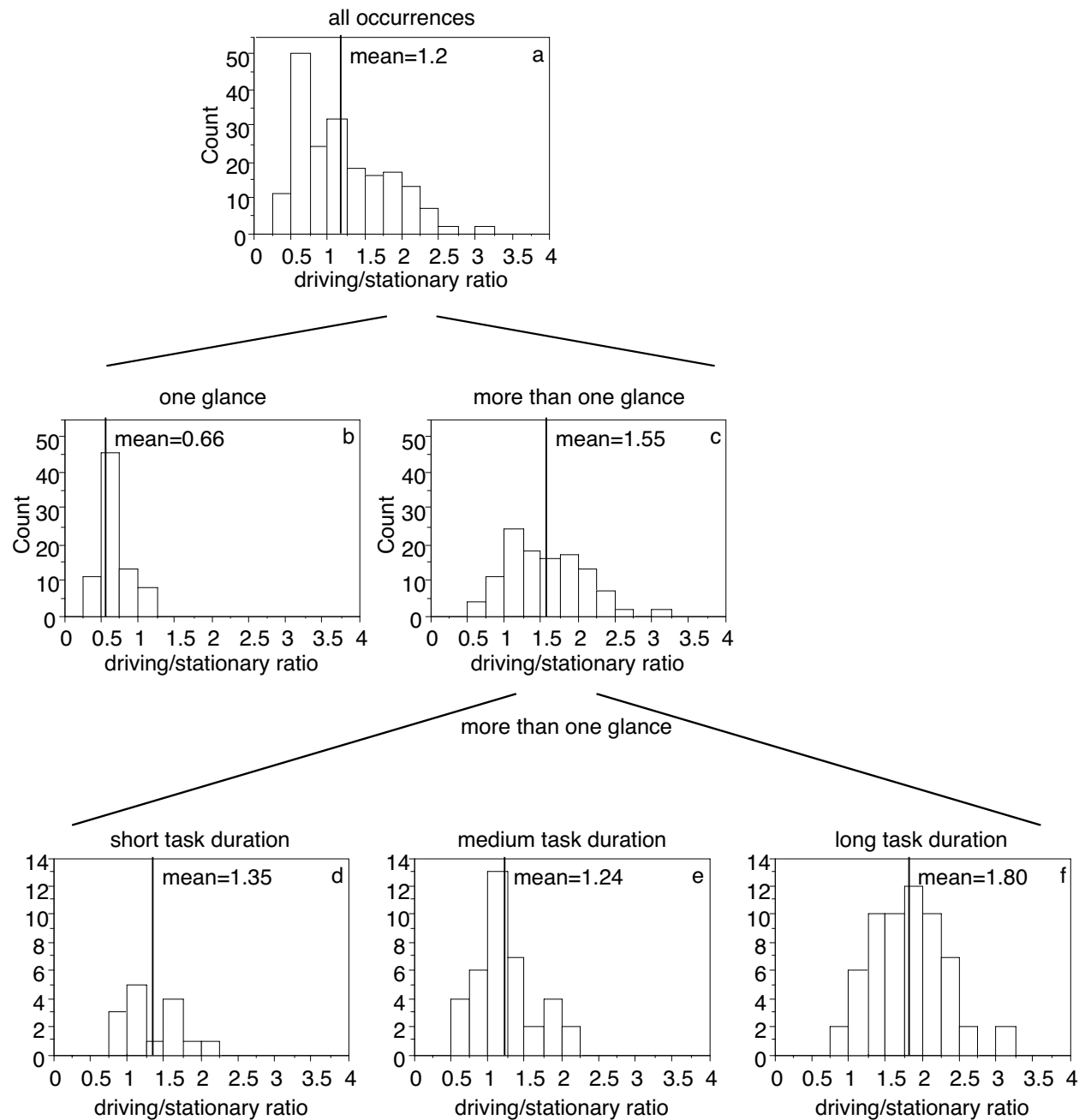

Figure 11. Frequency distribution of task completion time ratio between driving and stationary

The Effect of Driving on Total Glance Duration

The total glance duration was significantly shorter when driving (2860 versus 3500 ms, $p=0.0001$) (Figure 12). This effect was significantly larger for shorter questions than for longer questions ($p=0.0001$). There was no significant interaction between the effect of driving and age ($p=0.37$). However, older subjects had a longer total glance duration ($p=0.0006$).

Three explanations might be given to the pattern shown in Figure 12. (1) Time pressure: due to the time pressure to look back at the road, the task was performed more quickly, thus reducing the total glance duration. (2) Postponed processing: while driving, some of the processing time must have occurred when the subject was not looking at the display, thus reducing the total glance duration. (3) The cost of partitioning: longer questions took more than one glance, thus forcing some executive overhead as well as some reprocessing time due to forgetting. The increased cost of partitioning the task into several glances partially negated the effects of postponed processing and time pressure.

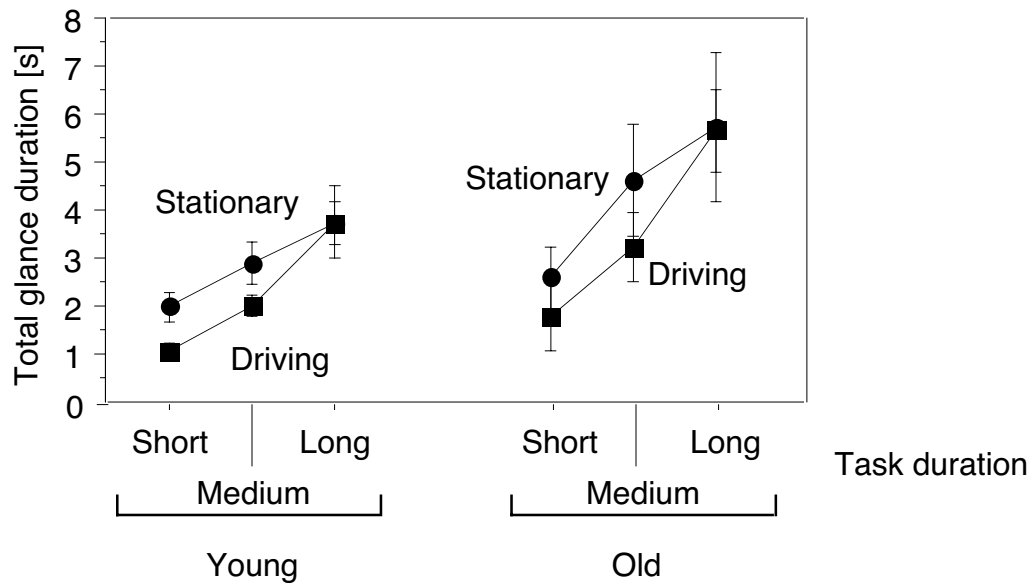

Figure 12. The effect of driving, task duration, and age on total glance duration

The Effect of Curvature on Glance Behavior

The subjects performed the map-reading tasks while driving on roads with 4 levels of curvature. These levels simulated 4 levels of visual demand, which were computed from the occlusion data discussed later in this results section. Data from the 3 sessions of driving while performing the task were used for the analysis of the curvature effect.

The effect of curvature on each of the 5 glance measures is described below.

The Effect of Curvature on Mean Glance Duration

The mean glance duration decreased as curves became sharper from 1800 ms in the straight sections to 1200 ms in the 194 m radii curve ($p=0.0001$). No significant interaction effects were found between curvature and age or curvature and gender.

The interaction between curvature and task duration was moderately significant ($p=0.048$) (Figure 13). The curvature effect was not as large when short questions were presented. This was probably because the short questions usually required only one glance, which was short enough not to interfere with the driving task.

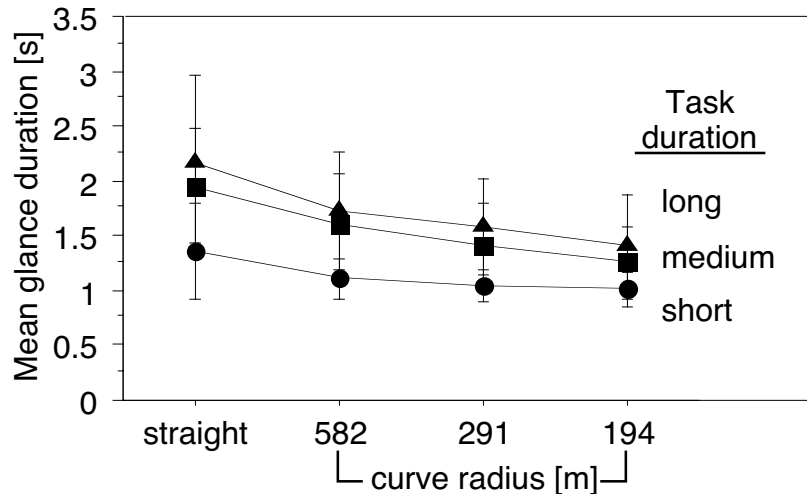

Figure 13. The effect of curvature by task duration on mean glance duration

The decrease in mean glance duration when curves were sharper can be attributed to the higher visual demand of driving in sharper curves. When the visual demand of driving increased, the subject could not afford to look away from the road for long periods of time. Therefore, there was a need to shorten the mean duration of glances.

The Effect of Curvature on the Number of Glances

The number of glances increased as curves became sharper ($p=0.047$). No significant interaction effects were found between curvature and age or gender.

The interaction between curvature and task duration was significant ($p=0.044$) (Figure 14). The curvature effect only appeared for the long questions, where the number of glances increased from 2.6 ± 1.4 on a straight road to 3.5 ± 1.2 on the sharpest curve.

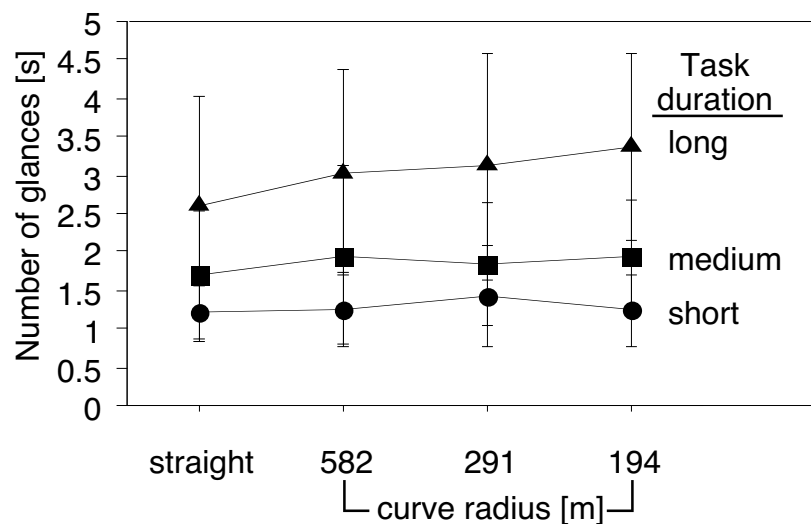

Figure 14. The effect of curvature and task duration on the number of glances

The Effect of Curvature on Total Glance Duration

The total glance duration decreased as curves became sharper ($p=0.0014$) (Figure 15). The interaction between curvature and age was moderately significant ($p=0.052$) and of curvature and gender was not significant.

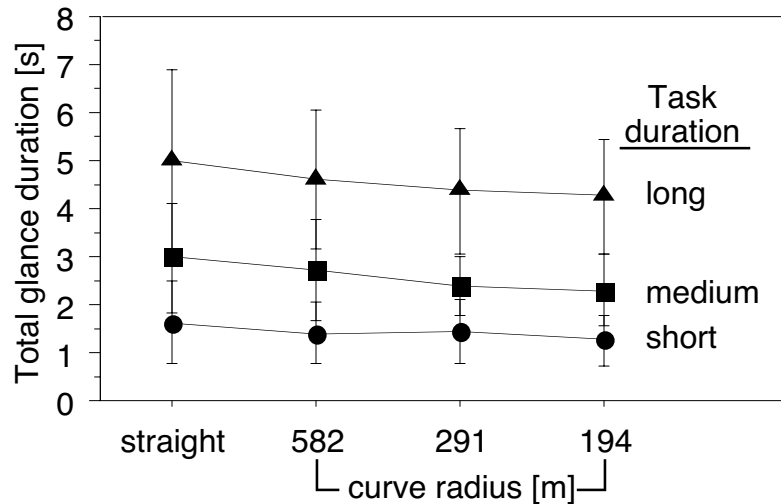

Figure 15. The effect of curvature and task duration on total glance duration

The total glance duration is the summation of the discrete glance times. Since the decrease in mean glance duration was relatively larger than the increase in the number of glances (see Figure 13 and Figure 14), the total glance duration decreased. The need to be more efficient in each glance resulted in shorter total glance duration.

The Effect of Curvature on Task Completion Time

Curvature did not significantly affect task completion time ($p=0.63$), though completion time slightly increased between the two sharper curvatures from 4.6 to 5.1 s (Figure 16).

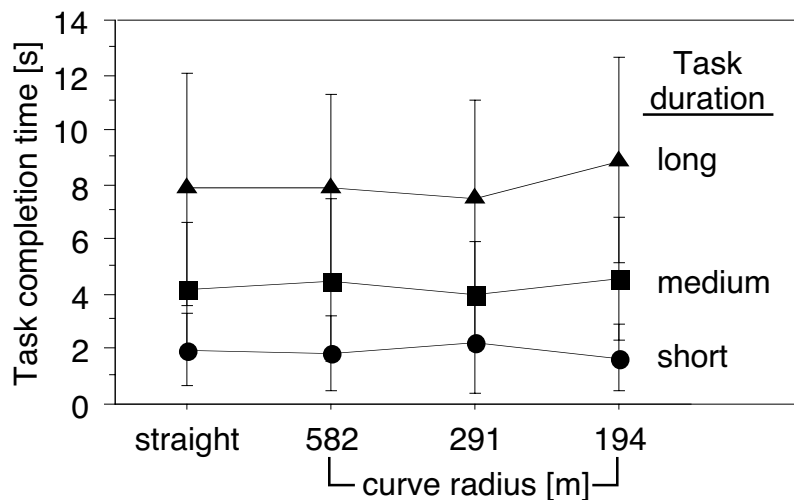

Figure 16. The effect of curvature and task duration on completion time
Note: the effect was not significant ($p=0.63$)

The Effect of Curvature on Mean Time Between Glances

The mean time between glances significantly increased as curves became sharper ($p=0.0004$) (Figure 17). The increase effect was greater for questions that resulted in long task durations than for the questions that resulted in short task durations ($p=0.0027$). This trend was similar for all age groups.

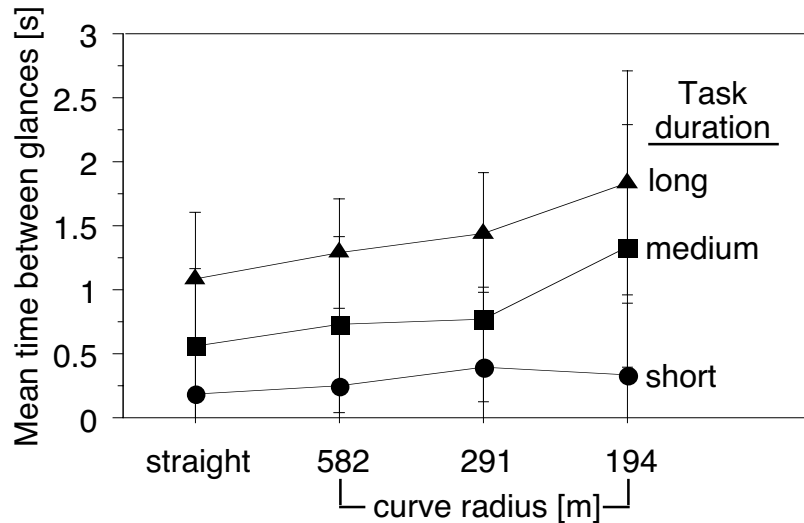

Figure 17. The effect of curvature and task duration on the mean time between glances

The Effect of Occlusion on Glance Behavior

In two of the sessions during which the task was performed while driving, the road scene was occluded whenever the subjects looked at the display. This was done for two purposes: (1) for data collection purposes: to prevent the subjects from looking at the road while looking at the secondary display; and (2) for comparison purposes: to provide better conditions for comparison with the occlusion sessions, in which no secondary task was performed but the road scene was intermittently occluded.

An additional session was performed without occluding the road scene to check the validity of performing the task with occlusion. Another purpose of running these two conditions together (with and without occluding the scene) was to investigate the role of peripheral vision while looking at the in-vehicle display. Any difference in performance between these two methods would indicate that one or more of the following may have occurred: (1) the lack of visual input from the periphery affected task performance, or (2) the subjects “peeked” to the road scene while they were supposed to be looking at the in-vehicle display, or (3) occluding the road scene caused the subjects to alter their glance behavior.

The effect of occlusion on each of the 5 glance measures is described below.

The Effect of Occlusion on Mean Glance Duration

The mean glance duration was moderately longer when not occluded ($p=0.036$). The interaction between curvature and occlusion was significant ($p=0.01$) (Figure 18). The rate of decrease in mean glance duration was shallower for the non-occluded condition. While the mean glance duration was similar on the straight road, in the 194 m radius curve it was 20% longer in the non-occluded condition (based on a pair-wise comparison within subject).

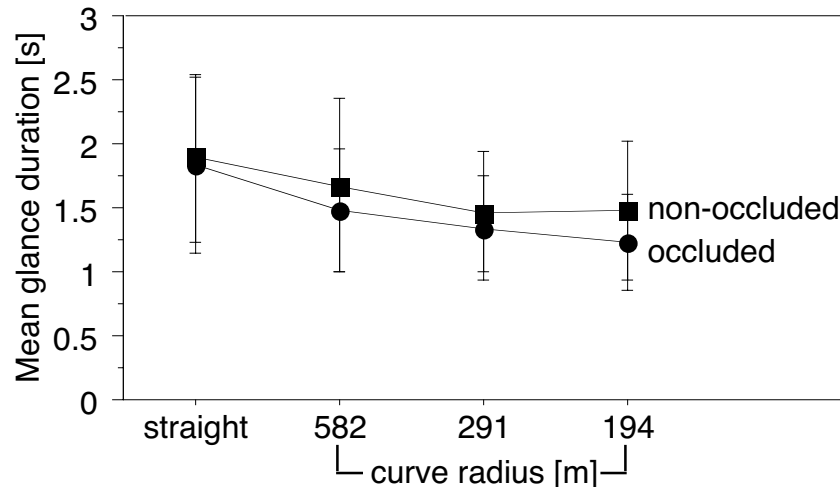

Figure 18. The effect of curvature and occlusion on the mean glance duration

The Effect of Occlusion on the Number of Glances

The number of glances was not significantly affected by the occlusion of the road scene while looking at the in-vehicle display ($p=0.67$).

The Effect of Occlusion on Total Glance Duration

The total glance duration was significantly longer when not occluded ($p=0.014$). The interaction between curvature and occlusion was not significant (Figure 19). On straight roads there was no significant difference in total glance duration. On the 194 m radius curves the total glance duration was 20% longer in the non-occluded condition.

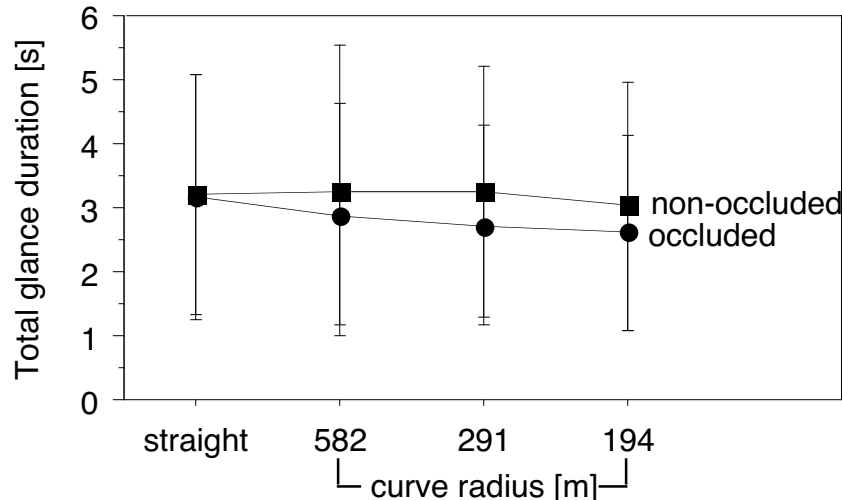

Figure 19. The effect of occlusion and curvature on total glance durations

The Effect of Occlusion on Task Completion Time

Task completion time was not significantly affected by occlusion ($p=0.21$).

The Effect of Occlusion on Mean Time Between Glances

The mean time between glances was not significantly affected by occlusion ($p=0.67$).

The Effect of Age and Gender on Glance Behavior

The performance differences between the age groups were rather large. However, this is not surprising given the large age difference between the two age groups. The effects of age and gender for each of the 5 glance dependent measures are shown in Table 7 and described below.

Table 7. Age and gender effects on glance behavior [s]

		All questions included		Only long questions included	
		Female	Male	Female	Male
Mean glance duration	Young	1.3±0.3	1.7±0.6	1.4±0.3	2.3±0.6
	Old	1.4±0.4	1.5±0.6	1.4±0.5	1.7±0.7
Number of glances	Young	1.7±0.8	1.3±0.5	2.5±0.7	1.9±0.4
	Old	2.5±1.3	2.9±1.5	3.7±1.2	4.3±1.5
Total glance duration	Young	2.1±1.1	2.4±1.3	3.4±0.6	4.0±0.8
	Old	3.2±1.7	4.0±2.1	5.0±1.2	6.2±1.5
Task completion time	Young	3.2±2.2	2.9±2.1	5.6±1.7	5.6±1.4
	Old	6.1±3.8	7.1±4.5	10.1±2.9	11.8±3.8
Mean time between glances	Young	0.6±0.7	0.4±0.6	1.3±0.3	1.1±0.5

	Old	1.3±0.9	1.2±0.7	1.8±0.8	1.6±0.7
--	-----	---------	---------	---------	---------

The Effect of Age and Gender on Mean Glance Duration

On average, mean glance duration was not significantly affected by age ($p=0.35$). However, there was a marginally significant gender effect ($p=0.096$), mainly between young males and young females. Young males had longer mean glance durations. This difference was even more profound when data was derived only from the long questions.

The Effect of Age and Gender on the Number of Glances

Older subjects made significantly more glances at the display than younger subjects ($p=0.002$). The difference due to age was larger for long questions.

The Effect of Age and Gender on Total Glance Duration

On average, the total glance duration was significantly longer for older subjects than for young subjects ($p=0.0003$). The older subjects took 60% longer looking at the display. In addition, male subjects took somewhat longer than did females ($p=0.13$). This difference was yet more profound when data was taken only from the long questions.

The Effect of Age on Task Completion Time

The task completion time was significantly longer for older subjects ($p=0.0001$). On average, it took older subjects 110% more time (more than twice as much) to complete tasks than it did for young subjects.

The Effect of Age on Mean Time Between Glances

The mean time between glances was significantly longer for older subjects ($p=0.0008$). On average, when older subjects looked back at the road, they looked twice as long.

Voluntary Occlusion

Visual Demand as a Function of Curvature

In the previous sections various glance measures were plotted as a function of curvature. The underlying assumption was that sharper curves imposed higher workload on the driver, and for lack of a better measure, they served as a good estimation of driver workload. However, using actual workload was thought to be better. In this experiment, therefore, actual workload (or visual demand) was obtained using the voluntary visual occlusion technique. The visual demand of each of the levels of curvature was measured using visual occlusion, thus quantifying the actual workload experienced by each of the subjects. As a reminder, visual demand was defined as the percentage of time the subject chose to see the road scene during each of the curves.

In the repeated measures design used, there were two between-subject factors: (1) age (young, old) and (2) gender (male, female); and two within-subject factors: (3) curve radius (four levels), and (4) curve direction (right, left). Curvature was significant ($p=0.0001$); age was significant ($p=0.008$); and gender was significant ($p=0.003$). The direction of the curve was not significant ($p=0.54$) and all the interactions were not significant.

For the purpose of analyzing visual demand as a function of road curvature, the visual demand was averaged across curve direction. This was justified by the fact that curve direction was not a statistically significant factor in workload estimates.

In general, the pattern of visual demand as a function of curvature matched expectations. There was a near linear increase in visual demand as a function of curvature (Figure 20).

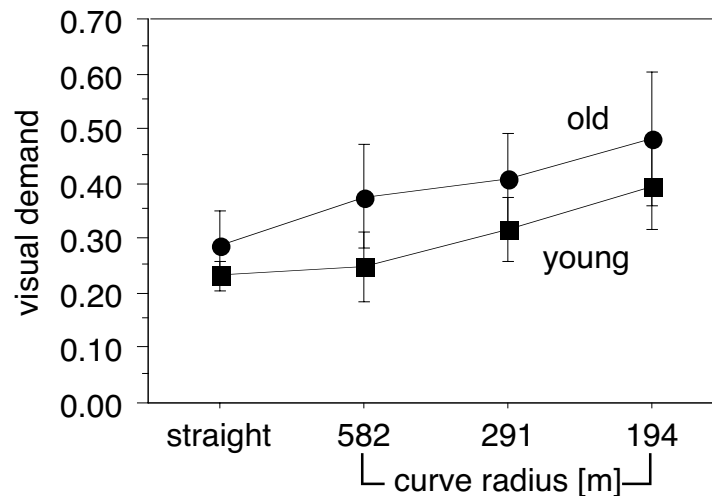

Figure 20. The effect of road curvature on visual demand as measured by visual occlusion (note: visual demand was calculated for each curve starting 10 s after the point of curvature).

In contrast to a previous occlusion study (Tsimhoni and Green, 1999), the occlusion data that was used to calculate visual demand did not include the first 10 s of the curve. This was done to avoid the instantaneous change in visual demand normally associated with the beginning of curves. Consequently, the visual demand level that was calculated was significantly lower than in the previous study (Equations 4 and 5). It is interesting to note, however, that the slope of the regression equation remained the same. Visual inspection of the demand profiles for Tsimhoni and Green suggest that if the same portion of those profiles were compared, the intercepts would probably be quite close as well.

$$\text{VisD (w/o the beginnings of curves)} = 0.252 + 34.5 * 1/R \quad R^2 = 0.98 \quad (4)$$

$$\text{VisD (first half of curves)} = 0.388 + 33.2 * 1/R \quad (\text{previous study}) \quad (5)$$

On average, visual demand was linearly related to road curvature. Therefore, it was possible to examine the effect of visual demand by replacing it with curvature. However, there was a large variability between subjects in how they perceived the different curves. Therefore, there might be some benefit in using the individual visual demand values per subject as measured by the voluntary occlusion method instead of the curve radii.

Using Visual Demand Instead of Curvature to Evaluate Performance

To check this hypothesis, two regression analyses were performed for each of the glance measures discussed earlier. The first regression analysis used the glance measure as a dependent variable and curvature as an independent variable. The second regression analysis used the same glance measure as a dependent variable and visual demand as an independent variable.

In general, the R^2 values were relatively low due to the large variability between subjects. However, a large increase in the value of R^2 was found in some of the regressions when the curvature values were replaced by actual visual demand values.

Mean Glance Duration as a Function of Visual Demand

The mean glance duration of long questions decreased as a function of curvature with an R^2 of only 0.18. Regression of the mean glance duration by visual demand resulted in a higher R^2 of 0.34 (Figure 21).

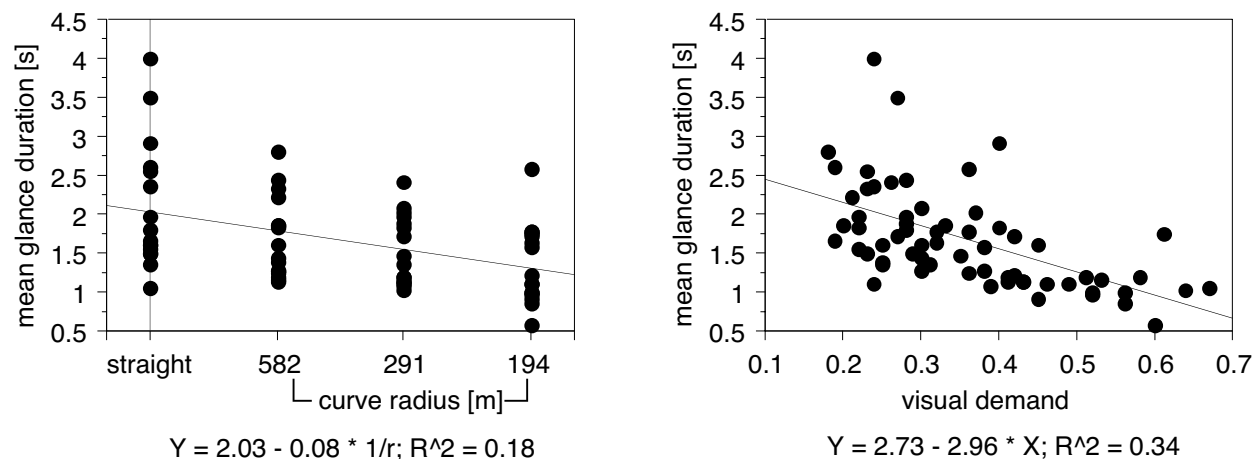

Figure 21. Regression of mean glance duration (long questions) by curvature and by visual demand

A similar analysis of the mean glance duration of medium questions resulted in an increase in R^2 from 0.24 to 0.36, respectively (Figure 22). However, for the short questions, there was a decrease in R^2 from 0.21 to 0.04, respectively.

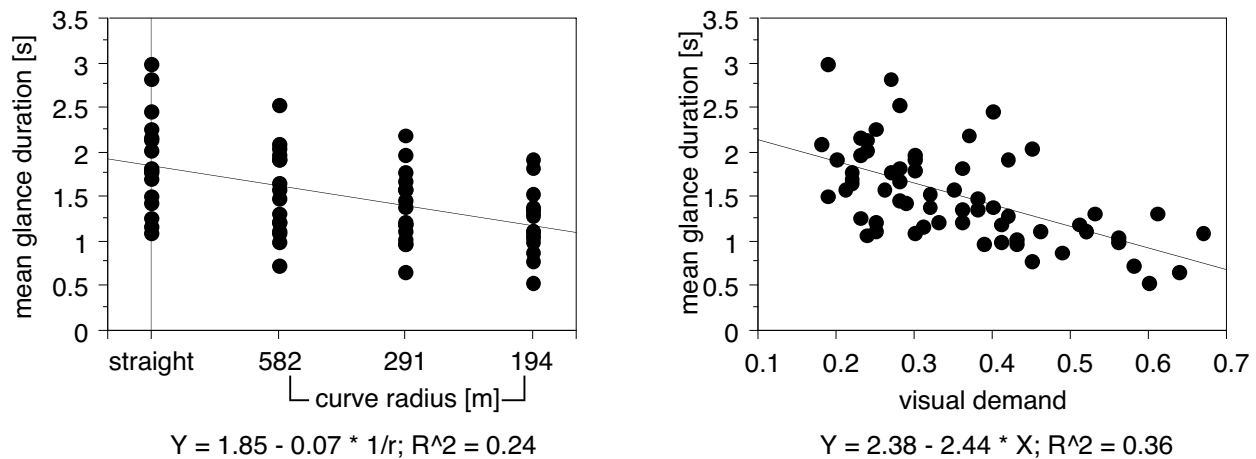

Figure 22. Regression of mean glance duration (medium questions) by curvature and by visual demand

Similar improvement was found for the number of glances and for the task completion time in all task durations. The total glance duration and the mean time between glances showed a decrease in R^2 . Table 8 presents the R^2 for the 5 measures of glance performance split by the task duration.

Table 8. The change in R^2 for each of the glance measures as a function of task duration

	Short question by radius, by visD	Medium question by radius, by visD	Long question by radius, by visD
Mean glance duration	0.21, 0.04	0.24, 0.36	0.18, 0.34
Number of glances	0.00, 0.11	0.00, 0.28	0.02, 0.15
Task completion time	0.00, 0.08	0.00, 0.23	0.01, 0.09
Total glance duration	0.04, 0.03	0.08, 0.02	0.06, 0.00
Mean time between glances	0.23, 0.01	0.06, 0.23	0.11, 0.09

Note: cells with increase in R^2 are gray.

Comparison of Visual Demand between Secondary Task and Voluntary Occlusion

In the previous subsection, visual demand values from the occlusion technique were used to predict parameters of glance behavior. Here, the same visual demand values were used to predict visual demand values calculated from the glance data. The predicted visual demand values are essentially the proportion of time the subjects looked at the road in each sequence of looking at the in-vehicle display and back at the road.

A comparison of the visual demand in the last secondary task session (Table 4, Activity J) to the visual occlusion session is shown in Figure 23. A near linear relation was found between the two sets of visual demand values. Moreover, a linear regression resulted in a slope of 0.5 (Equation 6), somewhat close to the expected ideal slope of 1.0.

$$\text{VisD of secondary task} = 0.32 + 0.5 * \text{VisD of occlusion}; \quad R^2 = 0.36 \quad (6)$$

However, there was an obvious shift towards higher visual demand values in the secondary task session than in the visual occlusion session. While the mean visual demand for the occlusion session was 0.34, it was 0.49 for the secondary task session. The mean of ratios was 1.53, ranging from 1.69 for straight roads to 1.33 for the sharpest curves.

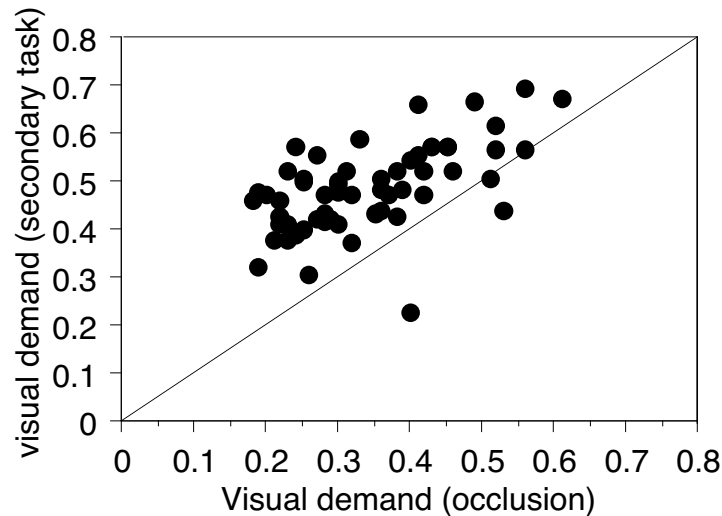

Figure 23. Comparison of visual demand between secondary task and voluntary occlusion

Driving Performance

The driving performance of subjects was quantified by 3 dependent measures: (1) lane excursions, (2) the standard deviation of the lateral position, and (3) the standard deviation of the steering wheel angle. For each of the task conditions (driving baseline, driving while performing the map-reading task, and driving with voluntary occlusion), the three measures are described below as a function of curvature.

Lane Excursions

For each road driven, the number of lane excursions was analyzed. For the sessions in which subjects performed the map-reading task while driving, the sampled section was from the point in time when the question was presented to the end of the allowed time to answer. This accumulated to 2 min of sampled driving time. For the driving session and for the occlusion session, comparable parts of the curves were sampled. Overall, 605 lane excursions occurred for all subjects throughout the study.

Since the width of one lane was 3.66 m (12 ft) and the width of the vehicle was 1.83 m (6 ft), a lane excursion was counted when the lateral position of the center of the vehicle exceeded 2.74 m (9 ft) (the right edge line was exceeded) or was under 0.91 m (3 ft) (the center line was exceeded) (Figure 24).

Different patterns of lane excursions were found for each of the conditions (Figure 25 A-D). In the driving baseline condition, although there were almost no excursions,

some excursions occurred in the straight section and the moderate curve. In the secondary task condition, as curves became sharper the number of excursions increased. In the visual occlusion condition, there was a higher rate of excursions for all curvatures except in the 194 m curve.

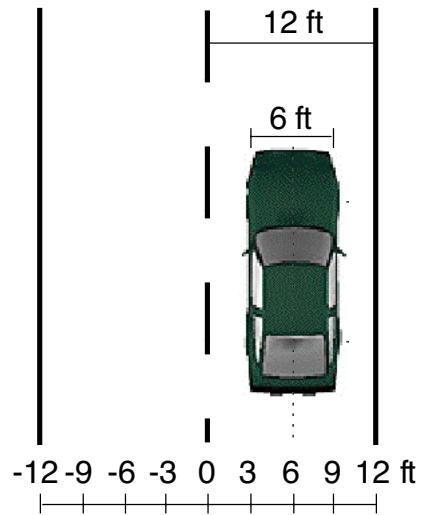

Figure 24. The lateral position of the vehicle

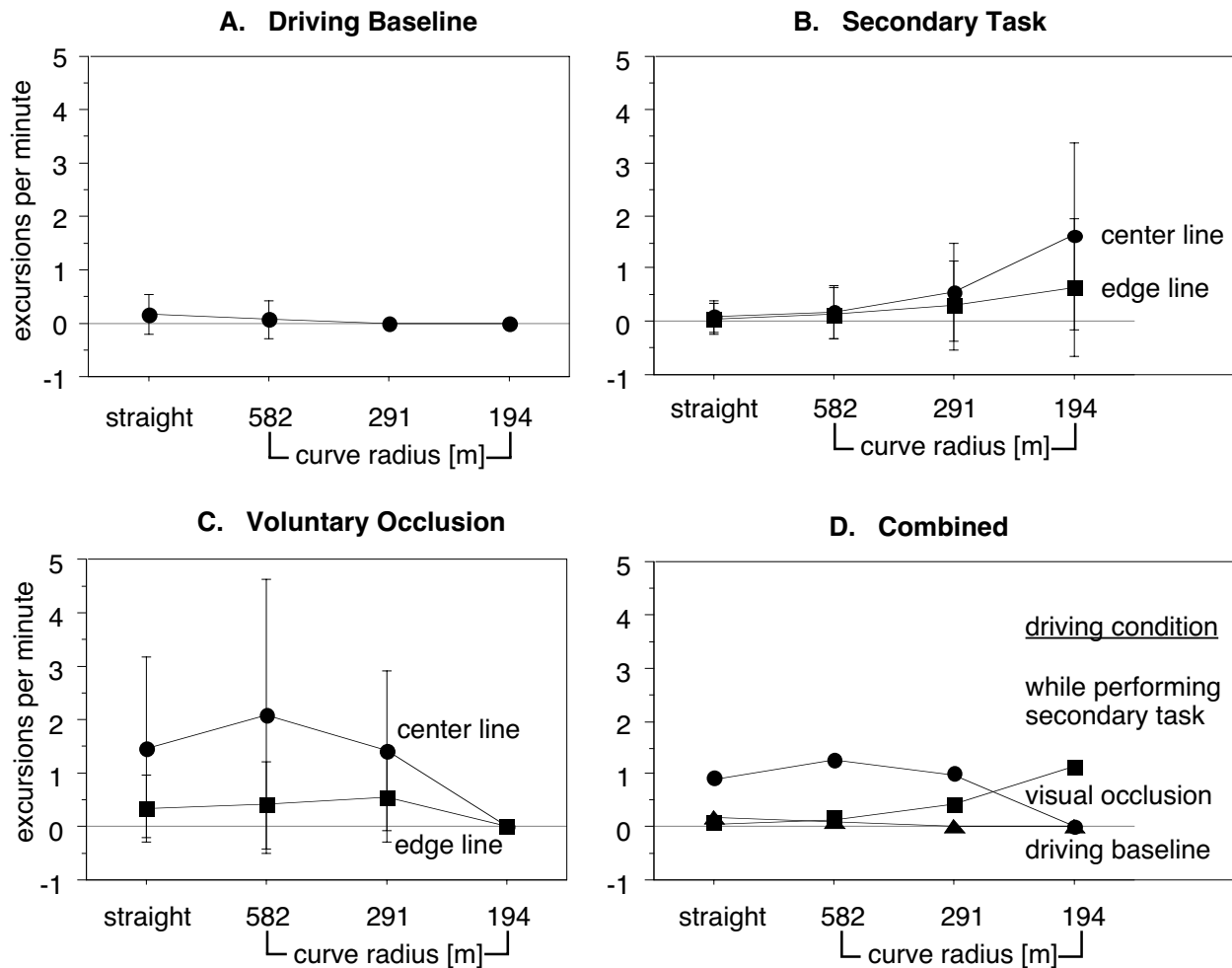

Figure 25 A-D. The effect of curvature on the rate of lane excursions

Lane Excursions in the Driving Baseline Session

When driving the simulator with no additional tasks, the number of lane excursions decreased as the curves became sharper ($p=0.01$) (Figure 25 A). Although the number of excursions was very small altogether, they were not distributed evenly across curvatures. On the straight road and on the 582 m radius curve there were only a few excursions (0.2 per minute, 0.1 per minute, respectively), whereas on the two sharper curves there were no excursions at all. Subjects probably paid more attention when they drove through the sharper curve and therefore no excursions occurred in the sharper curves.

Lane Excursions in the Secondary Task Session

The number of lane excursions increased as the curves became sharper ($p=0.0001$). Although the number of center line excursions was not significantly larger than the number of edge-line excursions ($p=0.10$), the interaction between curvature and excursion direction was significant ($p=0.02$) (Figure 25 B). The greater number of center excursions makes sense as center excursions had minimal consequences (no traffic) whereas edge excursions resulted in driving off the road, which was associated with torque feedback from the steering wheel and gravel sounds. It is noted that in contrast to other simulators, a reasonable amount of lateral instability

existed in this simulator, thus preventing the driver from holding the steering wheel at a fixed angle.

Lane Excursions in the Occlusion Session

The rate of excursions in the occlusion session was more than tenfold higher than in the driving baseline (0.77 excursions per minute with occlusion versus 0.06 in the baseline), and somewhat larger than in the secondary task condition (0.77 excursions per minute with occlusion versus 0.45 with the secondary task).

The number of lane excursions did not show a near linear pattern as the curves became sharper. The number of excursions for the 582 m radius curve was slightly larger than that of driving a straight road section. However, for sharper curves there was a consistent decrease in the number of lane excursions. In fact, the number of lane excursions for the sharpest curve (194 m) was zero. This conforms with the notion that in the sharp curves they looked at the road sufficiently due to the high cost of losing control, whereas in the more moderate curves they sacrificed their driving performance in order to view the road as minimal as possible. The effect of curvature was significant ($p=0.0003$), the effect of excursion direction (center versus edge) was significant ($p=0.003$), and the interaction between them was significant ($p=0.003$) (Figure 25 C).

Older subjects had fewer lane excursions than younger subjects ($p=0.05$). The interaction between age and line type was significant ($p=0.02$) (Figure 26). The lane excursions that were made by the younger subjects were mostly towards the center line. As mentioned earlier, younger subjects may have sacrificed their driving performance in order to minimize the amount of time spent looking at the road since no penalties were given for exceeding the center line. In contrast, the older drivers chose a more conservative strategy which improved their driving performance at the cost of looking at the road more frequently.

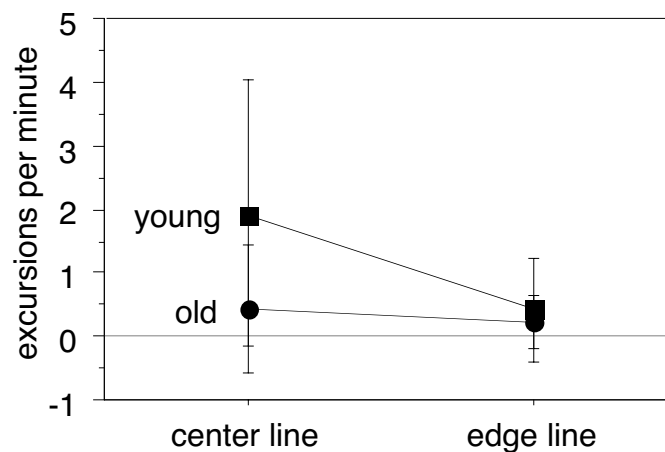

Figure 26. The effect of line type and age on the number of lane excursions when driving with voluntary occlusion

Standard Deviation of Lateral Position

For each session in which subjects performed the map-reading task while driving, 24 samples of 5 s of driving data were analyzed (1 sample for each question asked). The sampled section began after the question had been asked and ended 5 s later. For the driving baseline and the occlusion sessions, the sampled section began at the same location in the curve where the question would be asked and ended 5 s later.

The lateral position was recorded in feet at a sample rate of 30 per second. The standard deviation of lateral position [m] was used as a dependent measure of driving performance.

Figure 27 presents the standard deviation of lateral position in the three tested conditions. Interestingly, driving performance in the visual occlusion condition and while performing the secondary task were essentially identical. The pattern of the driving baseline as a function of curvature was similar but the magnitude of the lane position variability was much smaller.

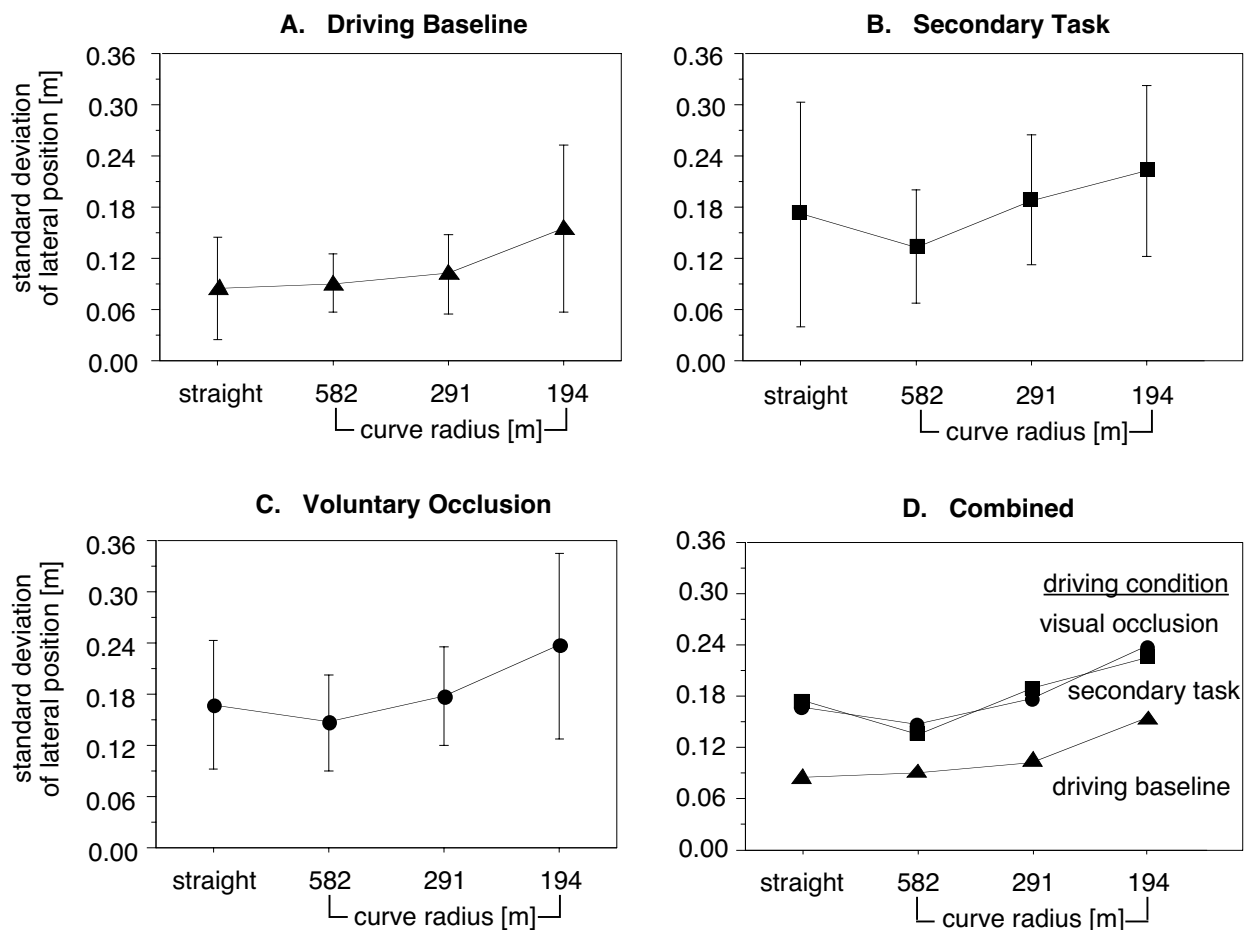

Figure 27 A-D. The effect of curvature on the standard deviation of lateral position

Lateral Position in the Driving Baseline Session

When driving the simulator with no additional tasks, the standard deviation of the lateral position increased as a function of curvature ($p=0.01$) (Figure 27). The differences between the first 3 levels of curvature were relatively small. However, a post-hoc Fisher's test revealed a significant difference between the 291 m curve and the 192 m curve ($p=0.03$).

Lateral Position in the Secondary Task Session

When driving and performing the secondary task, the standard deviation of the lateral position decreased from the straight section to the first level of curvature and increased thereupon ($p=0.0001$) (Figure 27). The absolute values were approximately twice as large as those of the driving baseline.

Lateral Position in the Occlusion Session

As in the secondary task condition, the standard deviation of the lateral position decreased from the straight section to the first level of curvature and increased thereupon ($p=0.06$) (Figure 27). The absolute values were similar to those of the secondary task condition, but the variability between subjects was larger.

The effect of age was significant as well ($p=0.008$). Older subjects had a mean value of 0.44, while younger subjects averaged 0.74. In addition, older drivers did not have a local decrease from the straight section to the first level of curvature, as did the younger subjects (this interaction was not significant).

Standard Deviation of Steering Wheel Angle

For each session in which subjects performed the map-reading task while driving, 24 samples of 5 s of driving data were analyzed (one sample for each question asked). The sampled section consisted of the 5-second period after the question had been asked. For the driving baseline and the occlusion sessions, the sampled section consisted of the 5-second period at the same location in the curve where the question would be asked.

The steering wheel angle was recorded in radians at a sample rate of 30 per second. The standard deviation of the steering wheel angle (radians) was used as a dependent measure of driving performance.

The optimal steering wheel angles for the straight section, and the 3 levels of curvature (582, 294, and 192 m) were 0.00, 0.20, 0.40, and 0.60 radians, respectively (0, 11.5, 23, and 34.5 degrees, respectively).

Figure 28 presents the standard deviation of steering wheel angle in the three tested conditions. Similar patterns occurred in all three conditions. The standard deviation of steering wheel angle was greatest in the secondary task condition. As expected, the overall pattern of the results bears some relationship to the standard deviation of lateral position, though the lateral position data might be more sensitive.

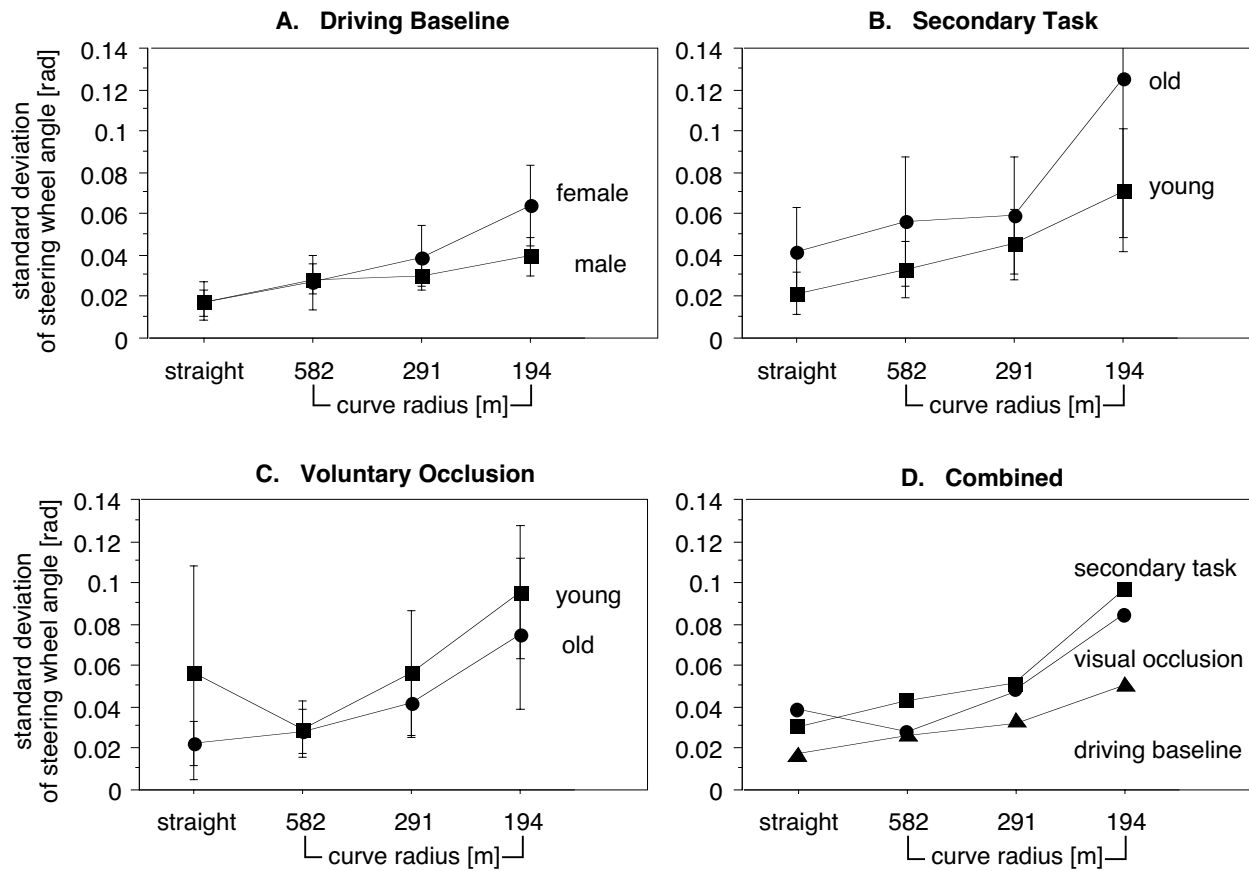

Figure 28 A-D. The effect of curvature on the standard deviation of steering wheel angle

Steering Wheel Angle in the Driving Baseline Session

When driving the simulator with no additional tasks, the standard deviation of the steering wheel angle increased as a function of curvature ($p=0.0001$) (Figure 28). Gender was not a significant factor ($p=0.21$). The interaction between curvature and gender was significant ($p=0.001$). Female subjects had a significantly larger standard deviation of steering wheel angle for the two sharper curves. Since this finding was not consistent with any of the other dependent measures, no attempt to explain it was made at this point.

Steering Wheel Angle in the Secondary Task Session

When driving and performing the secondary task, the standard deviation of the steering wheel angle increased as a function of curvature ($p=0.0001$) (Figure 28). The age effect and the interaction between curvature and age were both moderately significant ($p=0.07$ and $p=0.08$, respectively).

Steering Wheel Angle in the Occlusion Session

The standard deviation of the steering wheel angle increased as a function of curvature ($p=0.0001$) (Figure 28). Younger subjects had a moderately larger standard deviation than did older subjects ($p=0.07$). It is hypothesized that the larger values are a result of a higher level of risk taking by the younger subjects. However, the reader is reminded that the voluntary

occlusion method was applied for less than 30 minutes at the end of the study. It may well be that the described phenomenon would have been corrected if more training time with this technique were granted.

Subjective Ratings

Difficulty

The subjects were requested to rate the difficulty of the 4 different conditions on a scale of 1 to 6. The condition effect was significant ($p=0.0001$) (Figure 29). While the driving baseline was rated at 1, driving with the secondary task was rated at 3 when the scene was not occluded and at 4 when it was occluded. Using the voluntary occlusion technique was rated most difficult at 4.5.

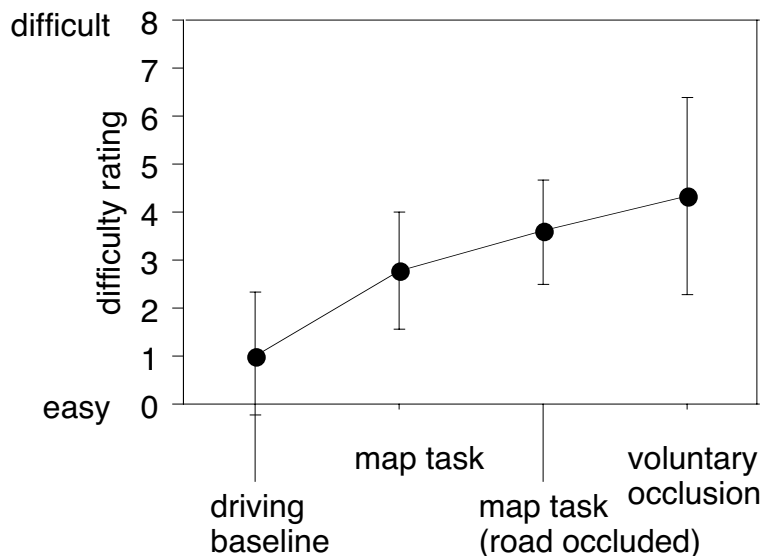

Figure 29. Difficulty ratings of the four experimental settings

Safety

There was a significant difference between the acceptability ratings of the conditions ($p=0.0001$) (Figure 30). While younger subjects followed a pattern similar to that of difficulty, older drivers rated the driving baseline as very easy, and rated all the rest as unacceptable. The age effect was significant ($p=0.03$), and its interaction with the condition was significant too ($p=0.01$). It could be that a ceiling effect occurred here, and that these tasks overwhelmed (at least some of) the older drivers.

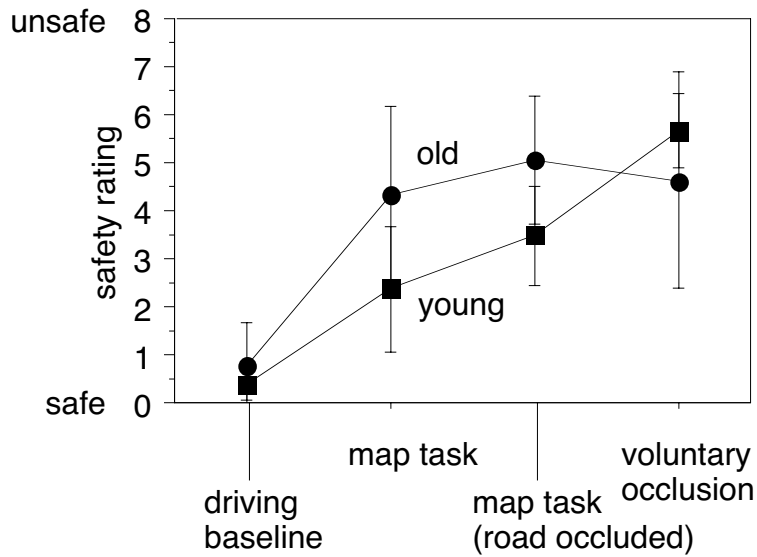

Figure 30. Safety ratings of the four experimental settings

Difficulty of Common Driving Tasks

The subjects were requested to rate the difficulty of common driving tasks.

“Using all of your driving experience, (not just what you did today), please rate the difficulty of performing each of these tasks while driving, using the scale below.”

The tasks appeared on the questionnaire in random order.

A full factorial ANOVA with age, gender, and question as independent factors, revealed statistical significance of age ($p=0.0001$) and question ($p=0.017$). As expected, older subjects rated the tasks more difficult (mean=4.0) than younger subjects (mean=3.3).

Table 9 presents the mean rating values across all subjects. In addition to ratings from the current study, the table presents data from three other studies. In a graphical comparison between the studies (Figure 31), a similar trend can be seen across the different studies. In fact, the data from the current study are extremely similar to those found by Green, Hoekstra, and Williams (1993), except that all the ratings are consistently higher by an average of 1.0. It is noted that a visual analog scale was used in the current study as opposed to using numbers in the previous study.

Table 9. Mean difficulty ratings for performing common tasks while driving

	Common driving task from 1 (not difficult) to 10 (extremely difficult)	(1) N=16	(2) N=43	(3)	(4) N=8
A	Turning on and off the car radio	2.3	1.5		1.1
B	Talking with other people in the car	2.3	1.8	1.3	1.5
C	Changing stations on the car radio using presets	2.4	1.7	2.8	2.1
D	Reading the speed on the speedometer	2.4	1.7		
E	Adjusting the fan speed on the car heater or AC	2.6	1.6	2.2	1.1
F	Drinking a beverage	4.2	3.3	3.5	4.3
G	Changing a tape cassette in a car stereo	4.6	3.6		3.1
H	Looking at street numbers to locate an address	5.6	4.4		4.0
I	Reading a map	6.9	5.3	7.9	4.5
	Mean by group	3.7	2.7	3.5	2.7

(1) Current study (visual analog scale)

(2) UMTRI 93-35: Green, Williams, Hoekstra, George, and Wen, 1993

(3) Kames, 1978

(4) UMTRI 93-32: Green, Hoekstra, and Williams, 1993

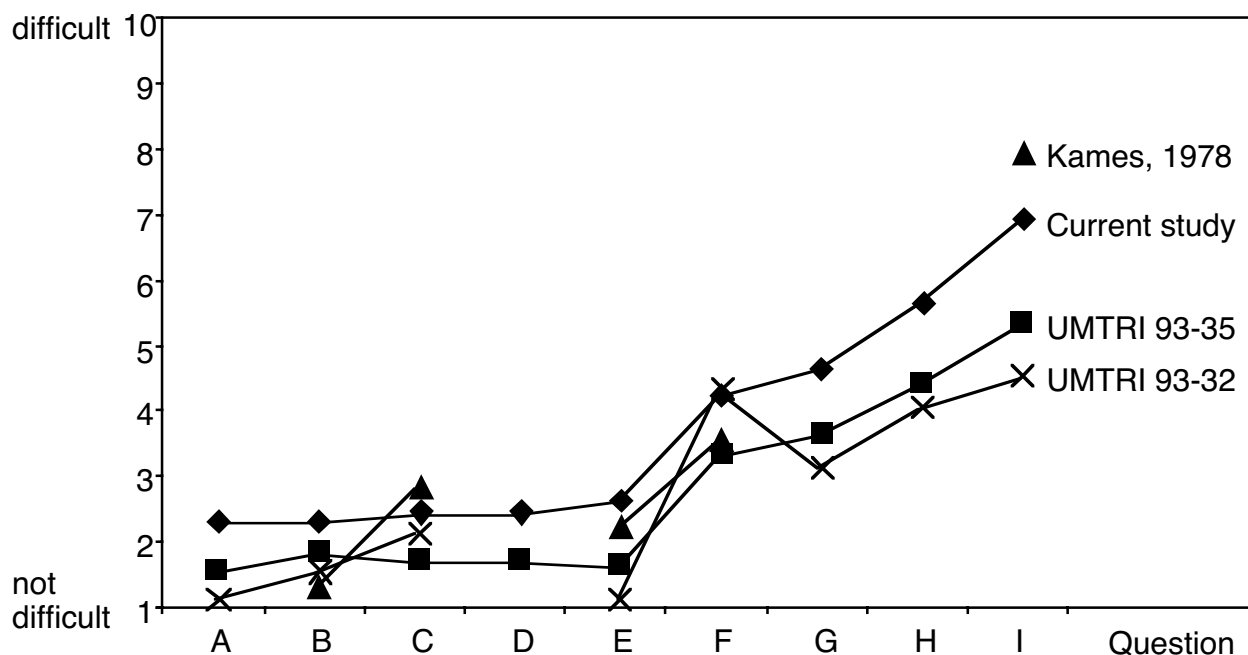

Figure 31. Mean difficulty ratings for performing common tasks while driving

In an attempt to link the subjective results of this study to data cited in the literature, the subjective ratings were compared with total glance duration as cited by Wierwille (1988). Only 4 of the tasks used in this study could be compared with the cited data (task D: reading the speed on the speedometer, task E: adjusting the fan speed on the car heater, task G: changing a tape cassette in a car stereo, and task I: reading a map). The mean number of glances of the 4 tasks excerpted from Wierwille were 1.26, 1.78, 2.06, and 5.21, respectively. The ratings in the current study were 2.4, 2.6, 3.6, and 6.9. It is noted that task I was defined as reading a map

while the cited data referred to reading a cross-street off an in-vehicle displayed map. Nevertheless, it should serve as an acceptable estimate.

Since there were only 4 data points, it was not surprising that the regression (Figure 32) resulted in a very high R^2 of 0.99. A logarithmic regression was slightly better than a linear regression. Furthermore, it was preferable due to the expected non-linear nature of this type of rating. A similar fit, performed with the total glance duration and with the mean glance duration, resulted in R^2 values of 0.98 and 0.74, respectively.

This regression was performed only to make the point that a high correlation existed between subjective ratings and the number of glances or the total glance duration, although this relationship was based on only 4 data points.

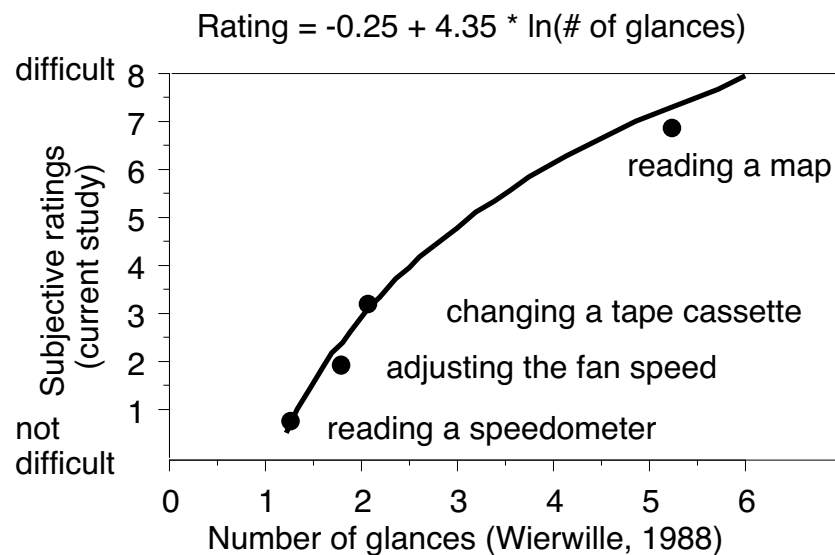

Figure 32. Regression of the subjective ratings by approximate number of glances

Mean Glance Duration

Subjects were asked how long they thought they could glance at a map without adverse effects to their driving (Figure 33). The overall mean of the estimations was 2.1 s (standard deviation of 1.1 s). Similarly the overall mean of glance times in the actual study was 2.1 s (standard deviation of 0.6). While several subjects made wild estimations (e.g., subjects 2 and 16 estimated 4 and 5 s, respectively), most of the subjects (11 out of 16) were within 30% of their actual mean glance time. For these subjects, the correlation between estimated and actual mean glance time was 0.75. There were no consistent differences in accuracy between age or gender groups.

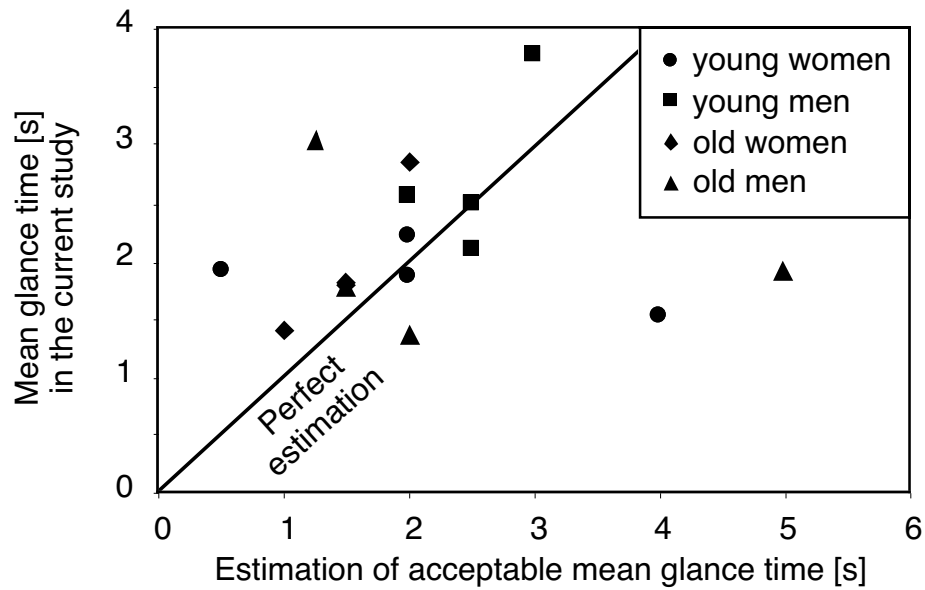

Figure 33. Subjective post-experiment estimation of mean glance duration

Simulator Realism

Subjects were asked to rate the realism of various aspects of the simulator. The overall mean responses are found in Table 10. The ratings fell between 5.9 and 7.7 (on a 1-to-10 scale), indicating that the subjects found the simulation somewhat realistic.

Table 10. Subjective rating of simulator realism
(on a scale from 1 (very artificial) to 10 (being very real))

Steering	7.7
Graphics (road scene)	5.9
Sound (engine and road sounds)	7.0
Vibration	7.4

CONCLUSIONS

1. How does task context (driving versus stationary) affect driver performance and behavior for a display-intensive in-vehicle task?

a) task completion time

Mean task completion time increased from 3.6 s to 4.7 s (+30%) when the task was performed while driving, due to the need to periodically look back at the road to drive safely. However, younger subjects performed the short task much faster while driving (probably because when they drove, they had a greater pressure to complete the task as soon as possible in order to look back at the road). Older subjects had a larger increase in task completion time due to driving (from 4.3 s to 6.5 s, +51%), and more so for longer questions (5.6 s to 11 s, +96%).

b) measures of glance behavior (total glance duration)

The total glance duration showed a similar trend of decreasing significantly for short questions (from 2.3 s to 1.4 s, -39%). However, for long tasks it remained unchanged while the task completion time increased.

2. How does driving workload affect driver performance and behavior for a display-intensive in-vehicle task?

In this study, three levels of curvature were used to impose three levels of controlled driving workload. As expected, the effect of curvature (and therefore of workload) on task performance was significant for most of the task performance measures.

a) task completion time

Surprisingly, task completion time was not significantly affected by curvature, (a surrogate of workload), although there was a slight increase in the 194 m curve from 4.6 s to 5.1 s.

b) measures of glance behavior

As curves became sharper, the mean glance duration decreased and the number of glances increased. The effect of curvature on the number of glances only appeared for the long questions, where the number of glances increased from 2.6 ± 1.4 on a straight road to 3.5 ± 1.2 on the sharpest curve. The total glance duration, a product of the number of glances and the mean glance duration, decreased as curves became sharper. This could indicate that the decrease in duration of individual glances was more substantial than the increase in their number. The mean time between glances significantly increased as curves became sharper, and more so for long questions.

c) driving performance

The rate of lane excursions increased as the curves became sharper. The standard deviation of the lateral position decreased from the straight section to the first level of curvature and increased as the curvature became sharper. The standard deviation of the steering wheel angle consistently increased as a function of curvature. The absolute values for the latter two measures (standard deviation of lateral position and of steering wheel angle) were approximately twice as large as those of the driving baseline.

3. How do age and gender affect driver performance and behavior for a display-intensive in-vehicle task?

a) task completion time

Task completion time by older drivers was significantly longer. No significant gender effects were found.

b) measures of glance behavior

Older subjects made significantly more glances at the display than younger subjects. Their total glance duration was therefore significantly longer. Their mean time between glances was significantly longer. The mean glance duration was not significantly affected by age. However, there was an age-gender interaction by which the mean glance duration was longer for young males.

c) driving performance

Older subjects showed worse driving performance. Their rate of lane excursions was larger, the standard deviations of their lateral position and of their steering wheel angle were larger too. Although these effects were not always statistically significant, these trends existed. Although a gender main effect was not found, women's driving performance was affected by curvature more than that of men.

4a. How does the method employed, the voluntary occlusion technique, affect driving performance?

Driving performance declined when the occlusion technique was employed. However, the decline pattern was relatively similar to the decline pattern of driving the vehicle while performing a secondary task.

The rate of excursions in the occlusion session was more than tenfold higher than in the driving baseline (0.77 versus 0.06 excursions per minute, respectively), and somewhat higher than in the secondary task condition (0.77 versus 0.45 excursions per minute). In a way, the subjects traded their driving performance for how much time they viewed the road scene. The decrease in excursion rate as a function of curvature suggests that they were less willing to make mistakes in the sharper curves, and therefore they looked at the road more of the time.

The standard deviation values of the lateral position and of the steering wheel angle in the occlusion condition were about twice as high as those in the driving baseline but similar to those

of the secondary task condition. The similarity suggests that the lateral control of the car in the occlusion condition was comparable to that of the secondary task condition.

4b. Is the visual occlusion technique predictive of glance behavior while using an in-vehicle display?

As in previous voluntary occlusion studies, visual demand in this study was linearly related to road curvature. Equation 7 shows a linear regression of visual demand by the reciprocal of curve radius:

$$\text{VisD (w/o the beginnings of curves)} = 0.252 + 34.5 * 1/R \quad R^2 = 0.98 \quad (7)$$

Visual demand of the road scene in a secondary task session was linearly related to visual demand in the occlusion session (Equation 8). Although the visual demand values of the secondary task session were higher, they were consistently related to the visual demand values that were measured in the visual occlusion session.

$$\text{VisD of secondary task} = 0.32 + 0.5 * \text{VisD of occlusion}; \quad R^2 = 0.36 \quad (8)$$

Regressing the various task performance measures by visual demand, rather than by curvature, resulted in higher R^2 values. For example, while the mean glance duration of long questions decreased as a function of curvature, the R^2 was only 0.18. Regression of the mean glance duration by visual demand resulted in a higher R^2 of 0.34. A similar analysis of the mean glance duration of medium questions resulted in an increase in R^2 from 0.24 to 0.36, respectively. Similar improvement in the R^2 for all question lengths was found for the number of glances and for the task completion time. The total glance duration and the mean time between glances showed a decrease in R^2 .

5. How does intermittent occlusion of the road-scene affect performance of the in-vehicle task?

The purpose of this question was twofold: (1) to assess the effect of occluding the screen (as was done in this study) on task performance, (2) to determine whether subjects used their peripheral vision to obtain information from the road scene while driving and glancing at the in-vehicle display and if so, did it affect their task performance.

The mean glance duration was moderately longer when not occluded and more so in sharper curves. The total glance duration was significantly longer too when not occluded, suggesting that subjects might have been less efficient when the road scene was not occluded due to a reduced pressure to look back at the road. The three other measures of task performance (number of glances, task completion time, and mean time between glances) did not change significantly.

6. What was the perceived difficulty and safety of the testing methods utilized in this study?

The difficulty of the driving baseline was rated at 1 (on a scale of 1 to 6). In contrast, driving with the secondary task when the scene was not occluded was rated at 3, and at 4 when the scene was occluded. Using the voluntary occlusion technique was rated at the highest difficulty of 4.5. The safety of the testing methods was rated at a similar pattern by young subjects. However, older subjects rated the driving baseline as very easy and rated the other methods as nearly unacceptable.

When subjects were asked how long they thought they could glance at a map without adverse effects to their driving, the overall mean of the responses was 2.1 ± 1.1 s. Most, but not all, of the subjects performed within 30% of their post experiment estimations.

Closing thoughts

The big picture of how drivers respond to workload demands is similar in some ways to what was assumed at the beginning of this experiment, different in others. As visual demand of driving increased (as characterized by the occlusion method), drivers responded by making shorter glances, but more of them. So in fact, the total glance time (the eyes-off-the-road time), remained constant. What was unexpected was that for brief tasks, those requiring a single glance, glance durations were less while driving, a reaction to the time pressure of driving. Moreover, as the demand of the road increased (as measured by occlusion), so did the time between glances inside the vehicle. However, it should be noted that when drivers made voluntary glances to the road, the glances were on the order of 1.0 to 1.5 s (greater than the 0.5 s forced by the occlusion method) leading to slightly greater estimated visual demand for the road.

Most surprising, however, was that there was very little change in task completion time as the visual demand of driving increased. Some stretching was expected, and while it did occur, the effect was not significant. What did occur, however, was a significant degradation of driving performance. Interestingly, that degradation was reflected in the occlusion data. This suggests that despite instructions that driving should be the primary task, the map-reading tasks did capture drivers' attention to the detriment of driving safety.

Readers should bear in mind that these findings pertain primarily to visually intensive tasks of relatively short total duration (under 10 s while driving.) Extension of these findings to longer and more interactive tasks should be based on further experimental work.

REFERENCES

- Fitzpatrick, K., Wooldridge, M.D., Tsimhoni, O., Collins, J.M., Green, P., Bauer, K., Parma, K.D., Koppa, R., Harwood, D.W., Krammes, R.A., and Poggioli, B. (1999). Alternative Design Consistency Rating Methods for Two-Lane Rural Highways (Technical Report FHWA-RD-99-xx), McLean, VA: U.S. Department of Transportation, Federal Highway Administration.
- George-Maletta, K., Hunter, D.R., Brooks, A., Lenneman, J., and Green, P. (1998). Preliminary Examinations of the Time to Read Electronic Maps: The Effects of Text and Graphic Characteristics, (Technical Report UMTRI-98-36), Ann Arbor, MI: The University of Michigan Transportation Research Institute.
- Green, P. (1999a). Estimating Compliance with the 15-Second Rule for Driver-Interface Usability and Safety, Proceedings of the Human Factors and Ergonomics Society 43rd Annual Meeting, Santa Monica, CA: Human Factors and Ergonomics Society (to appear).
- Green, P. (1999b). Navigation System Data Entry: Estimation of Task Times (Technical Report UMTRI-99-17) , Ann Arbor, MI, The University of Michigan Transportation Research Institute.
- Green, P. (1999c). The 15-Second Rule for Driver Information Systems, ITS America Ninth Annual Meeting Conference Proceedings, Washington, D.C.: Intelligent Transportation Society of America, CD-ROM.
- Green, P. (1999d). Visual and Task Demands of Driver Information Systems (Technical Report UMTRI-98-16), Ann Arbor, MI: The University of Michigan Transportation Research Institute.
- Green, P., Hoekstra, E., and Williams, M. (1993) On-The-Road Tests of Driver Interfaces: Examination of a Navigation System and a Car Phone (Technical Report UMTRI-93-35), Ann Arbor, MI: The University of Michigan Transportation Research Institute.
- Green, P., Williams, M., Hoekstra, E., George, K. and Wen, C. (1993). Initial On-the-Road Tests of Driver Information System Interfaces: Examination of Navigation, Traffic Information, IVSAWS, and Vehicle Monitoring (Technical report UMTRI-93-32), Ann Arbor, MI: The University of Michigan Transportation Research Institute.
- Kames, A.J. (1978, November). A Study of the Effects of Mobile Telephone Use and Control Unit Design on Driving Performance. IEEE Transactions on Vehicular Technology, VT-27(4), 282-287.

- MacAdam, C.C., Green, P.A., and Reed, M.P. (1993). An Overview of Current UMTRI Driving Simulators, UMTRI Research Review, July-August, 24(1), 1-8.
- Michon, J.A. (1993) Generic Intelligent Driver Support, London, U.K.: Taylor and Francis.
- Nowakowski, C. and Green, P. (1998). Map Design: An On-the-Road Evaluation of the Time to Read Electronic Navigation Displays (Technical Report UMTRI-98-4), Ann Arbor, MI: The University of Michigan Transportation Research Institute.
- Olson, A. and Green, P. (1997). A Description of the UMTRI Driving Simulator Architecture and Alternatives (Technical report UMTRI-97-15), Ann Arbor, MI: The University of Michigan Transportation Research Institute.
- Reed, M. and Green, P. (1999). Comparison of Driving Performance on-Road and in a Low-Cost Driving Simulator Using a Concurrent Telephone Dialing Task, Ergonomics, 42(8), 1015-1037.
- Senders, J.W., Kristofferson, A.B., Levison, W.H., Dietrick, C.W., and Ward, J.L. (1967). The Attentional Demand of Automobile Driving, Highway Research Record #195, Washington, D.C.: National Academy of Sciences, Transportation Research Board, 15-33.
- Sivak, M. (1996). The Information That Drivers Use: Is It Indeed 90% Visual? Perception, 25, 1081-1089.
- Society of Automotive Engineers (1999). SAE Recommended Practice J2364 – Navigation and Route Guidance Function Accessibility While Driving, (Committee draft of May 26, 1999) Warrendale, PA: Society of Automotive Engineers.
- Tsimhoni, O. and Green, P. (1999). Visual Demand of Driving Curves Determined by Visual Occlusion, paper presented at the Vision in Vehicles 8 Conference, Boston, MA, August 22-25, 1999.
- Wierwille, W.W., Antin, J.F., Dingus, T.A., and Hulse, M.C. (1988). Visual Attentional Demand of an In-Car Navigation Display System, in Gale, A.G., Freeman, M.H., Haslegrave, C.M., Smith, P., and Taylor, S.P., (eds.), Vision in Vehicles II, Amsterdam, Elsevier Science, 307-316.
- Wooldridge, M., Bauer, K., Green, P., and Fitzpatrick, K. (2000). Comparison of Workload Values Obtained from Test Track, Simulator, and On-Road Experiments, paper to be presented at the Transportation Research Board Annual Meeting, Washington, D.C.

APPENDIX A – LIST OF 100 STREET NAMES PRESENTED IN THE MAPS

Aaron	Connor	Jenna	Melissa
Abigail	Crystal	Jesse	Michael
Adam	Daniel	Jessica	Molly
Adrian	David	John	Natalie
Alex	Derek	Joseph	Nathan
Alexa	Diana	Joshua	Nicole
Alicia	Dylan	Julia	Noah
Allison	Emily	Justin	Olivia
Alyssa	Emma	Katie	Paige
Amanda	Eric	Kelly	Patrick
Amber	Erica	Kevin	Rachel
Andrea	Erin	Kristen	Richard
Andrew	Ethan	Kyle	Robert
Anna	Evan	Laura	Ryan
Anthony	Gabriel	Lauren	Samuel
Ashley	Grace	Leslie	Sarah
Bailey	Hannah	Lindsey	Sean
Brandon	Isaac	Luis	Sophia
Brian	Isaiah	Maria	Steven
Brooke	Jack	Mariah	Sydney
Carlos	Jacob	Marissa	Thomas
Charles	James	Mark	Tiffany
Chelsea	Jared	Mary	Trevor
Claire	Jasmine	Matthew	Vanessa
Cody	Jason	Megan	William

Note: these names were taken from www.babycenter.com/babynames/names98.html.

APPENDIX B – PRE-TEST BIOGRAPHICAL FORM

Name: _____ #: _____

Date: _____

Pre Test Biographical Form

Name: _____	Date of Birth: ____/____/____ month day year
(please circle:)	
Male Female	
Left Handed Right Handed	Occupation: _____
In how many previous UMTRI studies have you participated? _____	

What kind of motor vehicle do you drive the most?
make: _____ model: _____ year: _____
Miles you drive per year: _____
How many years of driving? _____ Professional Driving? _____
Is the total miles driven over 30,000? yes no
In how many accidents have you been involved, during the past 5 years? _____
If you were driving on a 3-lane highway, what lane would you typically drive in?
Left Center Right

Do you wear glasses (or contact-lenses) while driving?
(Glasses, Contact lenses, Reading glasses, Bifocal, Multifocal)
Do you wear glasses (or contact-lenses) in any other situation?
(Glasses, Contact lenses, Reading glasses, Bifocal, Multifocal)
Comments: _____

FOR THE EXPERIMENTER

Far Vision: (Landolt Rings)													
1	2	3	4	5	6	7	8	9	10	11	12	13	14
T	R	R	L	T	B	L	R	L	B	R	B	T	R
20/200	20/100	20/70	20/50	20/40	20/35	20/30	20/25	20/22	20/20	20/18	20/17	20/15	20/13
Depth Vision										Color Vision			
1	2	3	4	5	6	7	8	9	12	5	26	6	16
B	L	B	T	T	L	R	L	R					

APPENDIX C – CONSENT FORM

SUBJECT CONSENT FORM for a Simulator Study

The purpose of this simulator study is to examine driver behavior while using an in-vehicle display. There is a considerable interest in using in-vehicle displays to present the driver with navigation guidance and for other purposes. Navigation guidance can be extremely useful for getting around in an unfamiliar environment and finding alternative routes in traffic congestion. However, the added task of looking at displays and retrieving information is a concern with driving safety.

In the experiment today, you will be presented with electronic maps, which will appear on a display inside the car. You will be shown a series of maps and will answer questions about each map. A computerized voice will announce the questions and you will have to respond by saying the answer out loud. After performing this task without driving the simulator, you will repeat it while driving at a cruise-controlled speed of 45 miles per hour. You will steer with your left hand, and whenever you want to look at the map, press a button with your right hand to make the map appear.

After completing these tasks, you will drive the simulator with an occlusion device. Your task will be to drive the simulator while pressing a foot switch which will let you see the road scene for half a second. You may press the foot switch as many times as you think is necessary to stay on the road. Please remember your main task is to remain on the road. If you go off the road, you may have to repeat the session.

The entire study will take approximately two and a half hours to complete. You will be paid \$35 upon completion of the experiment. You will be videotaped throughout the duration of the experiment for analysis purposes.

Some people experience motion discomfort in the simulator. If this occurs, tell the experimenter immediately, and he will stop the experiment. You can withdraw from the study at any time and for any reason. You will be paid regardless.

If you have any questions, please do not hesitate to ask the experimenter at any time.

Thank you for your participation.

Is it ok to show videotaped segments of your test session in presentations to UMTRI visitors, reports, conferences and meetings? (This is not required for participation in the study but is useful to have. Your name will not be used.)

Yes _____ No _____

I have reviewed and understand the information presented above. My participation in this study is entirely voluntary.

Subject Name (PRINTED): _____ Date: _____

APPENDIX D – DATA COLLECTION SHEET

SUBJECT NUMBER:

SUBJECT INITIALS:

Circle: Y O / M F

Experimenter's Data Collection Sheet

1	Answer	✓	Given
A	Hannah		
B	Samuel		
C	Robert		
D	Alicia		
E	Katie		
F	Mariah		
G	Michael		
H	Mary		
I	Alicia		
J	Melissa		
K	Justin		
L	Kristen		

2	Answer	✍	Given
B	Allison		
A	Claire		
C	Bailey		
D	Nicole		
E	Ryan		
F	Joseph		
G	Laura		
H	Jenna		
I	Abigail		
J	Brandon		
K	Jessica		
L	Kevin		

3	Answer	✍	Given
A	Evan		
B	Kevin		
C	Grace		
D	Amber		
E	Jack		
F	Adrian		
G	Lindsey		
H	Ethan		
I	Dylan		
J	Emily		
K	Justin		
L	Dylan		

6	Answer	✍	Given
B	Allison		
A	Claire		
C	Bailey		
D	Nicole		
E	Ryan		
F	Joseph		
G	Laura		
H	Jenna		
I	Abigail		
J	Brandon		
K	Jessica		
L	Kevin		

7	Answer	✓	Given
A	Amanda		
B	Megan		
C	Olivia		
D	Sophia		
E	Anthony		
F	Mark		
G	Marissa		
H	Katie		
I	Charles		
J	Emma		
K	Jared		
L	Samuel		

8	Answer	✍	Given
A	Natalie		
B	John		
C	Alex		
D	Nicole		
E	Jesse		
F	Leslie		
G	Connor		
H	Brandon		
I	Trevor		
J	Chelsea		
K	Cody		
L	Alyssa		

9	Answer	✍	Given
A	Abigail		
B	Cody		
C	Adam		
D	Leslie		
E	Mary		
F	Hannah		
G	Michael		
H	Amber		
I	Brooke		
J	James		
K	Joshua		
L	Jason		

10	Answer	✍	Given
A	Gabriel		
B	Thomas		
C	Aaron		
D	Crystal		
E	Patrick		
F	Kristen		
G	Thomas		
H	Natalie		
I	Brian		
J	Luis		
K	Ethan		
L	Lauren		

	Answer	✓	Given
A	Mary		
B	Emily		
C	Melissa		
D	Emma		
E	Andrea		
F	Chelsea		
G	Alexa		
H	Claire		
I	Olivia		
J	Thomas		
K	Joshua		
L	Charles		

	Answer	✍	Given
A	Julia		
B	Diana		
C	Claire		
D	Katie		
E	Sarah		
F	Isaac		
G	Isaac		
H	Charles		
I	Brooke		
J	Carlos		
K	Grace		
L	Jenna		

	Answer	✍	Given
A	Gabriel		
B	Daniel		
C	Andrew		
D	Tiffany		
E	Lindsey		
F	Noah		
G	Eric		
H	Alyssa		
I	Jacob		
J	Paige		
K	Amanda		
L	Richard		

Patrick

APPENDIX E – POST-TEST EVALUATION FORM

Post-Test Evaluation Form

During the experiment you drove in 4 different experimental settings:

- (1) just driving,
- (2) driving while glancing at the map to retrieve information, (road scene occluded)
- (3) driving while glancing at the map to retrieve information, (road scene always visible)
- (4) driving using the visual occlusion device (footswitch).

Please rate the difficulty and the acceptability of each of the experimental settings:

Difficulty

very easy very difficult

(1) just driving		_____	
(2) driving and glancing at the map (scene occluded)		_____	
(3) driving and glancing at the map (scene visible)		_____	
(4) driving using the visual occlusion device		_____	

Acceptability

very safe very dangerous

(1) just driving		_____	
(2) driving and glancing at the map (scene occluded)		_____	
(3) driving and glancing at the map (scene visible)		_____	
(4) driving using the visual occlusion device		_____	

Using an Electronic Map

Have you ever used an electronic map in a vehicle while driving? Yes No

If you had to use an electronic map while driving your vehicle, how long do you think you could glance at the map without adverse effects to you driving? _____ seconds

Using all of your driving experience (not just what you did today), please rate the difficulty of performing each of these tasks while driving, using the scale below.

Difficulty	very easy	very difficult
(1) Changing the stations on the car radio using presets	-----	
(2) Turning on and off the car radio	-----	
(3) Adjusting the fan speed on the car heater	-----	
(4) Looking at street numbers to locate an address	-----	
(5) Reading a map	-----	
(6) Talking with other people in the car	-----	
(7) Reading the speed on the speedometer	-----	
(8) Drinking a beverage	-----	
(9) Changing a cassette tape in the car stereo	-----	

Simulator Realism	very artificial	very real
(1) Steering	-----	
(2) Graphics (road scene)	-----	
(3) Sound (engine and road sounds)	-----	
(4) Vibration	-----	

Do you have any other comments about this study?

APPENDIX F – FONT SIZE CHOICE FOR STREET NAMES ON MAPS

The maps used in the current study were similar to those used in a previous study (Nowakowski and Green, 1998). In that study, significant point-size effects were found in two separate parts of the study. In the simulator part, 14-pt Helvetica was found to have the fastest response time, whereas in the on-road study, 12-pt Helvetica was found to be best overall. It was hypothesized by the authors that in the on-road study the 12-pt Helvetica was better than the 14-pt because it did not produce as much clutter. See Table for letter sizes and angles.

	Font and point size [pt]	Stroke width [Arc mins]	Character height [Arc mins]	H/SW ratio
Previous study On-road	Helvetica 12	3.85	14.4	3.75:1
	Helvetica 14	4.4	16.5	3.75:1
Previous study Simulator	Helvetica 14	4.6	17.2	3.75:1
Current study	Helvetica 16 (Mac OS 8)	3.2	17	5.3:1

For the current study, the characters were of similar height to those of the previous study. The 16-pt Helvetica characters spanned 17 arc min in height from the drivers view, which resembled the 14-pt size characters from the previous study. However, since the Mac operating system in the current study was different, the stroke height-to-width ratio was different. The characters in the current study were similar in height to 14-pt from the previous study, but their strokes were thinner.

Since maps in the current study had only 12 street names, the larger font did not cause clutter.

APPENDIX G – DATA ANALYSIS

Glance data

Overall, data from 2112 responses were collected (12 maps presented in each of 11 sessions to 16 subjects). Since some responses entailed more than one glance, the total number of glances recorded was larger (3605). Most of the analysis was performed using Excel (Microsoft Excel 98 for Macintosh), and Statview (SAS Statview 5.0.1 for Macintosh).

In the first phase of the data analysis, data from all runs were collected into one large database for all subjects. Each data point was stamped with the subject's number, age, and gender, as well as information describing its characteristics (e.g., driving/stationary, curvature, direction of curve, task complexity, session number). Then, consecutive glances for each task were collected, and glance measures (described earlier in Table 6) were calculated for each task.

In the second phase of the data analysis, the glance data set was coded for subject errors based on information that had been collected manually by the experimenter on the data collection form (appendix D). There were 3 types of errors: (1) The subject gave a wrong street name as an answer. This may have been because the street name was read incorrectly (e.g., Amanda, Andrea) or because the subject chose the wrong icon and therefore gave a name of the wrong street. (2) The subject did not have sufficient time to reply, so several glances were made, but the correct answer was not found. (3) The subject did not look at the map display due to various reasons (such as not hearing the question). A total of 82 errors were made in test sessions (5.3% of all the questions). Seventy of the 82 errors were made by older subjects. There was a large decrease in the number of errors from practice sessions to test sessions, but within test sessions the percentage of errors stayed fairly constant. The error rate for stationary sessions was 3.9%, versus 5.8% while driving.

Of the 82 errors, 42 were type 1 (wrong answer), 33 were type 2 (insufficient time), and 7 were type 3 (no glances). Errors of type 1 and of type 3 were dropped from the data set. Errors of type 2 were left in the data set because they represented an experimental limitation rather than subject error. (See Figure 3 for maximum times to answer each type of question). The total glance duration and the task completion times were longer than the rest of the data (and would have been even longer had the experimental limitation not existed). These data were not deleted to avoid bias towards shorter total glance durations.

In the third phase, smaller subsets of the large data set were created to be used in ANOVA for each of the following issues: (1) driving versus stationary, (2) the effect of curvature, and (3) occluded versus non-occluded. The ANOVA were performed separately for each of the aforementioned data subsets.

Voluntary occlusion

Overall, 6310 key presses were made by all the subjects to see the road using the occlusion technique. The data analysis began with filtering the key presses from the simulator driving

files. Then, key presses for each curve were collected separately. Momentary visual demand was then calculated using Equation 9.

$$\text{VisD}_i = \frac{0.5}{t_i - t_{i-1}} \quad \begin{array}{l} \text{VisD}_i = \text{visual demand over time interval from } t_{i-1} \text{ to } t_i \\ t_{i-1} = \text{clock reading at previous information request [s]} \\ t_i = \text{clock reading at current information request [s]} \\ 0.5 = \text{time increment during which subject had vision [s]} \end{array} \quad (9)$$

Next, the mean visual demand value was calculated for each curve starting 10 s after the beginning of the curve (point of curvature) and ending 10 s before the end of the curve (point of tangency). For each subject, one value of visual demand was assigned for each degree of curvature based on about 1 min of driving.

Driving performance

Driving data were collected by the simulator at 30 Hz for each of the roads driven. The relevant data (lateral position and steering wheel angle) were taken from the data files. For excursion rate, the lateral position was compared with the lane position. A lane excursion was recorded each time the lateral position was outside of the lane boundaries. The number of lane excursions in each session was then summarized for each road curvature. Since curves were not necessarily equal in length, the excursions are reported as rate per minute.

The standard deviation of lateral position and of steering wheel angle was collected for each task separately. The interval over which standard deviation was computed was the first 5 s after the question had been asked. Since the questions asked and the time to reply were different between questions, a short interval was chosen as a common low denominator that sufficed for all tasks.

Subjective rating

The post-test evaluation forms (Appendix E) consisted of difficulty and safety ratings and a time estimation question. The analog scale ratings were measured using a ruler and converted to numbers. Basic statistics of the ratings were then calculated.

The problem subject

After the initial data analysis was performed, it was found that the data collected from subject 14 could not be used because the subject had not followed all the instructions properly. In particular, his driving performance was not acceptable, and he could not perform the occlusion session as required. Since the experimenters felt that it might not be appropriate to remove his data from the statistical analysis, the statistical analysis was performed twice, with and without his data, and no substantial differences were found. The P-values that are reported in the report include his data so as not to artificially improve the statistical power by throwing out the extremes. However, his data were dropped from all the figures of glance behavior, voluntary occlusion, and driving performance because the experimenters felt his data did not represent normal driving.